



UNI|SOURCE  
PARTS



OFFICE FURNITURE PARTS  
**BUYER'S GUIDE**

# WELCOME

Unisource has been supplying work environments since 1992 with high quality parts. Our desire is to provide you, our valued customer, the products and service you deserve. You will find our staff knowledgeable, the quality of our products superior, and our commitment unparalleled.

We are pleased to provide you with a comprehensive catalog of office furniture OEM and replacement parts. We are very excited about the improvements and additions we have made to our catalog and our product offering.

- There is a greater selection of parts and sizes, particularly, within our universal (generic) component products.
- Our catalog format has been revised to enable you to easily find the part(s) you require.
- We are always available to handle special requests. If you do not find the part you need in our catalog, or have a unique need, contact our customer service department at [cs@unisourceparts.com](mailto:cs@unisourceparts.com) and we will do whatever possible to support your requirements.

In addition to our catalog we recommend that you utilize our website at [www.unisourceparts.com](http://www.unisourceparts.com) to stay current on additional product offerings. When you register online (with permission) you will receive notification on our monthly parts special. Also, do not forget to check out the clearance center for heavily discounted parts.



UNI | SOURCE  
PARTS

# CONTENTS



## TABLE LEGS

Single Peninsula.....	p.5
C-Legs.....	p.6
T-Legs.....	p.7
X-Base Legs.....	p.8
Double Peninsula.....	p.8
O-Legs.....	p.8
Café Height Legs.....	p.9
Atlas Table Bases.....	p.10

4



## STORAGE SOLUTIONS

Pedestals.....	p.13
Laterals.....	p.16
Vertical Files.....	p.21
Storage Cabinets.....	p.22
Towers.....	p.24
Bookcases.....	p.27
Open Plan Storage.....	p.28
Overhead Storage.....	p.30
Storage Accessories.....	p.31

12



## UNIVERSAL

Spray Paint.....	p.33
Lighting.....	p.34
Work Surface Products.....	p.36
Wall Mounting Strips.....	p.38
Fabric Stretch Machine.....	p.39
Paper Management.....	p.40
Steelcase Leap Chairs.....	p.41
Steelcase Criterion Chair.....	p.42

32



## HERMAN MILLER

Panel Blank Hardware.....	p.45
Raceway Parts.....	p.46
Power Accessories.....	p.49
Glass Stackers.....	p.51
End Caps.....	p.54
Connectors.....	p.56
Shelving.....	p.62
Panel Blanks.....	p.64
AO2 Work Surfaces & Hardware.....	p.68

44



## OTHER BRANDS

Steelcase Hardware.....	p.73
Haworth Hardware.....	p.73

72



## REFERENCES

Table Leg Sample Color Chart.....	p.75
Storage Sample Color Chart.....	p.76
Cushioned Top Pedestal Fabric Color Chart.....	p.78
Steelcase Chair Fabric Color Chart.....	p.80
Melamine Work Surface Color Choices.....	p.81
High Pressure Work Surface Color Choices.....	p.82
Frequently Asked Questions.....	p.84
Shipping Transit Times.....	p.86
Terms & Conditions of Sale.....	p.87

74

# TABLE LEGS



# SINGLE PENINSULA LEGS

## SINGLE PENINSULA LEGS



### 2" SINGLE PENINSULA LEG WITH GLIDES

SKU	UI.0004.01.XX								
Dimensions	27 3/4"H x 2"W								
Weight	6 lbs								
Price (BU)	\$18.00								
Painted Price*	\$29.50								
Color Options	<table border="1"> <tr> <td>BU</td> <td>MT</td> <td>HT</td> <td>HF</td> </tr> <tr> <td>LG</td> <td>LT</td> <td>PL</td> <td>SW</td> </tr> </table>	BU	MT	HT	HF	LG	LT	PL	SW
BU	MT	HT	HF						
LG	LT	PL	SW						

A welded 2" tubular base with a 6" x 6" steel mounting plate. Includes 1" black screws and 1 1/2" adjustable glides.



### 4" SINGLE PENINSULA LEG WITH GLIDES

SKU	UI.0004.02.XX								
Dimensions	27 3/4"H x 4"W								
Weight	11 lbs								
Price (BU)	\$29.00								
Painted Price*	\$40.50								
Color Options	<table border="1"> <tr> <td>BU</td> <td>MT</td> <td>HT</td> <td>HF</td> </tr> <tr> <td>LG</td> <td>LT</td> <td>PL</td> <td>SW</td> </tr> </table>	BU	MT	HT	HF	LG	LT	PL	SW
BU	MT	HT	HF						
LG	LT	PL	SW						

A welded 4" tubular base with a 6" x 6" steel mounting plate. Includes 1" black screws and 1 1/2" adjustable glides.



### 2" SINGLE PENINSULA LEG WITH CASTERS

SKU	UI.0004.03.XX								
Dimensions	27 3/4"H x 2"W								
Weight	6 lbs								
Price (BU)	\$22.50								
Painted Price*	\$34.00								
Color Options	<table border="1"> <tr> <td>BU</td> <td>MT</td> <td>HT</td> <td>HF</td> </tr> <tr> <td>LG</td> <td>LT</td> <td>PL</td> <td>SW</td> </tr> </table>	BU	MT	HT	HF	LG	LT	PL	SW
BU	MT	HT	HF						
LG	LT	PL	SW						

A welded 2" tubular base with a 6" x 6" steel mounting plate. Includes 2" dual wheel caster with lock and 1" black screws.



### 2" SINGLE PENINSULA SQUARE LEG

SKU	UI.0024.01.XX								
Dimensions	27 3/4"H x 2"W								
Weight	6 lbs								
Price (BU)	\$36.50								
Painted Price*	\$48.00								
Color Options	<table border="1"> <tr> <td>BU</td> <td>MT</td> <td>HT</td> <td>HF</td> </tr> <tr> <td>LG</td> <td>LT</td> <td>PL</td> <td>SW</td> </tr> </table>	BU	MT	HT	HF	LG	LT	PL	SW
BU	MT	HT	HF						
LG	LT	PL	SW						

A welded 2" cubed base with a 6" x 6" steel mounting plate. The column is offset and positioned from the corner of the mounting plate. Includes 1" black screws and 1 1/2" adjustable glides.

## SINGLE ADJUSTABLE PENINSULA LEGS



### 2" ADJUSTABLE LEG WITH GLIDES

SKU	UI.0004.04.BU	
Dimensions	28-40"H x 2"W	
Weight	7 lbs	
Price (BU)	\$41.50	
Color Options	<table border="1"> <tr> <td>BU</td> </tr> </table>	BU
BU		

A welded 2" tubular base with a 6" x 6" steel mounting plate. Adjust between 28" to 40" nominally, with 1" increments using a locking push-pin. Includes 1 1/2" adjustable glides.



### 2" ADJUSTABLE LEG WITH CASTERS

SKU	UI.0004.05.BU	
Dimensions	28-40"H x 2"W	
Weight	7 lbs	
Price (BU)	\$42.00	
Color Options	<table border="1"> <tr> <td>BU</td> </tr> </table>	BU
BU		

A welded 2" tubular base with a 6" x 6" steel mounting plate. Includes 2" dual wheel caster with lock. Adjust between 28" to 40" nominally, with 1" increments using a locking push-pin.

\* PAINTED LEGS WILL REQUIRE A MINIMUM OF 8 TO BE ORDERED - 2 WEEK LEAD TIME  
 \* IF LESS THAN 8 ORDERED, A \$60.00 UPCHARGE WILL BE ADDED TO YOUR ORDER

# C-LEGS

## C-LEG WITH GLIDES



### C-LEG WITH GLIDES

A welded 2" tubular base with a 6" x 8" steel mounting plate. Includes 1" black screws and 1 1/2" adjustable glides. Available in two depths: 22" (actual) for a 24" deep work surface, and 28" (actual) for a 30" deep work surface.

SKU	DIMENSIONS	WEIGHT	PRICE (BU)	PAINTED PRICE*	COLOR OPTIONS									
UI.0006.01.XX	27 3/4"H x 22"D	11 lbs	\$34.25	\$45.75	<table border="1"> <tr> <td>BU</td> <td>MT</td> <td>HT</td> </tr> <tr> <td>HF</td> <td>LG</td> <td>LT</td> </tr> <tr> <td>PL</td> <td>SW</td> <td></td> </tr> </table>	BU	MT	HT	HF	LG	LT	PL	SW	
BU	MT	HT												
HF	LG	LT												
PL	SW													
UI.0006.02.XX	27 3/4"H x 28"D	12 lbs	\$36.00	\$47.50	<table border="1"> <tr> <td>BU</td> <td>MT</td> <td>HT</td> </tr> <tr> <td>HF</td> <td>LG</td> <td>LT</td> </tr> <tr> <td>PL</td> <td>SW</td> <td></td> </tr> </table>	BU	MT	HT	HF	LG	LT	PL	SW	
BU	MT	HT												
HF	LG	LT												
PL	SW													

## C-LEG WITH CASTERS



### C-LEG WITH CASTERS

A welded 2" tubular base with a 6" x 8" steel mounting plate. Includes 1" black screws and 2" lockable casters. Available in two depths: 22" (actual) for a 24" deep work surface, and 28" (actual) for a 30" deep work surface.

SKU	DIMENSIONS	WEIGHT	PRICE (BU)	PAINTED PRICE*	COLOR OPTIONS									
UI.0006.03.XX	27 3/4"H x 22"D	11 lbs	\$37.00	\$48.50	<table border="1"> <tr> <td>BU</td> <td>MT</td> <td>HT</td> </tr> <tr> <td>HF</td> <td>LG</td> <td>LT</td> </tr> <tr> <td>PL</td> <td>SW</td> <td></td> </tr> </table>	BU	MT	HT	HF	LG	LT	PL	SW	
BU	MT	HT												
HF	LG	LT												
PL	SW													
UI.0006.04.XX	27 3/4"H x 28"D	12 lbs	\$39.00	\$50.50	<table border="1"> <tr> <td>BU</td> <td>MT</td> <td>HT</td> </tr> <tr> <td>HF</td> <td>LG</td> <td>LT</td> </tr> <tr> <td>PL</td> <td>SW</td> <td></td> </tr> </table>	BU	MT	HT	HF	LG	LT	PL	SW	
BU	MT	HT												
HF	LG	LT												
PL	SW													

## FAN C-LEG WITH GLIDES



### FAN C-LEG WITH GLIDES

A welded 2" x 1" aluminum base with a 6" x 8" steel mounting plate. Includes 1" black screws and 1 1/2" adjustable glides. Available in 22" (actual) for a 24" deep work surface.

SKU	DIMENSIONS	WEIGHT	PRICE (BU)	PAINTED PRICE*	COLOR OPTIONS									
UI.0009.01.XX	27 3/4"H x 22"D	13 lbs	\$77.50	\$89.00	<table border="1"> <tr> <td>BU</td> <td>MT</td> <td>HT</td> </tr> <tr> <td>HF</td> <td>LG</td> <td>LT</td> </tr> <tr> <td>PL</td> <td>SW</td> <td></td> </tr> </table>	BU	MT	HT	HF	LG	LT	PL	SW	
BU	MT	HT												
HF	LG	LT												
PL	SW													

\* PAINTED LEGS WILL REQUIRE A MINIMUM OF 8 TO BE ORDERED - 2 WEEK LEAD TIME  
 \* IF LESS THAN 8 ORDERED, A \$60.00 UPCHARGE WILL BE ADDED TO YOUR ORDER

# T-LEGS

## T-LEG WITH GLIDES



### T-LEG WITH GLIDES

A welded 2" tubular base with a 6" x 8" welded steel mounting plate. Includes 1" black screws and 1 1/2" adjustable glides. Available in three depths: 16" (actual) for an 18" deep work surface, 22" (actual) for a 24" deep work surface, and 28" (actual) for a 30" deep work surface.

SKU	DIMENSIONS	WEIGHT	PRICE (BU)	PAINTED PRICE*	COLOR OPTIONS
UI.0007.00.XX	27 3/4"H x 16"D	10 lbs	\$33.00	\$44.50	BU MT HT
UI.0007.01.XX	27 3/4"H x 22"D	12 lbs	\$37.00	\$48.50	HF LG LT
UI.0007.02.XX	27 3/4"H x 28"D	12 lbs	\$42.00	\$53.50	PL SW

## T-LEG WITH CASTERS



### T-LEG WITH CASTERS

A welded 2" tubular base with a 6" x 8" welded steel mounting plate. Includes 1" black screws and 2" lockable casters. Available in two depths: 22" (actual) for a 24" deep work surface, and 28" (actual) for a 30" deep work surface.

SKU	DIMENSIONS	WEIGHT	PRICE (BU)	PAINTED PRICE*	COLOR OPTIONS
UI.0007.03.XX	27 3/4"H x 22"D	11 lbs	\$37.50	\$49.00	BU MT HT
UI.0007.04.XX	27 3/4"H x 28"D	12 lbs	\$42.50	\$54.00	HF LG LT PL SW

## ARCHED T-LEG



### ARCHED T-LEG

A welded 2" tubular arched base with a 6" x 8" steel mounting plate. Includes 1" black screws and 1 1/2" adjustable glides. Available in two depths: 22" (actual) for a 24" deep work surface, and 28" (actual) for a 30" deep work surface.

SKU	DIMENSIONS	WEIGHT	PRICE (BU)	PAINTED PRICE*	COLOR OPTIONS
UI.0008.01.XX	27 3/4"H x 22"D	11 lbs	\$36.50	\$48.00	BU MT HT
UI.0008.02.XX	27 3/4"H x 28"D	11 lbs	\$41.50	\$53.00	HF LG LT PL SW

\* PAINTED LEGS WILL REQUIRE A MINIMUM OF 8 TO BE ORDERED - 2 WEEK LEAD TIME  
\* IF LESS THAN 8 ORDERED, A \$60.00 UPCHARGE WILL BE ADDED TO YOUR ORDER

# X-BASE + END SUPPORT LEGS

## X-BASE LEG



### X-BASE LEG

A welded X-shaped base with an 8" x 8" steel mounting plate. Includes 1" black screws and 1 1/2" adjustable glides. Available in three depths: 22" (actual) for a 24" square/round work surface, 28" (actual) for a 30" square/round work surface, and 34" (actual) for a 36" square/round work surface.

SKU	DIMENSIONS	WEIGHT	PRICE (BU)	PAINTED PRICE*	COLOR OPTIONS
UI.0010.01.XX	27 3/4"H x 22"D	18 lbs	\$48.00	\$59.50	BU MT HT HF
UI.0010.02.XX	27 3/4"H x 28"D	20 lbs	\$55.50	\$67.00	LG LT PL SW
UI.0010.03.XX	27 3/4"H x 34"D	26 lbs	\$74.00	\$85.50	

## ARCHED X-BASE LEG



### ARCHED X-BASE LEG

A welded X-shaped arched base with an 8" x 8" steel mounting plate. Includes 1" black screws and 1 1/2" adjustable glides. Available in three depths: 22" (actual) for a 24" square/round work surface, 28" (actual) for a 30" square/round work surface, and 34" (actual) for a 36" square/round work surface.

SKU	DIMENSIONS	WEIGHT	PRICE (BU)	PAINTED PRICE*	COLOR OPTIONS
UI.0013.01.XX	27 3/4"H x 22"D	15 lbs	\$50.00	\$61.50	BU MT HT HF
UI.0013.02.XX	27 3/4"H x 28"D	17 lbs	\$56.50	\$68.00	LG LT PL SW
UI.0013.03.XX	27 3/4"H x 34"D	19 lbs	\$64.00	\$75.50	

## DOUBLE PENINSULA LEG



### DOUBLE PENINSULA LEG

A welded 2" double column base with structural cross bars that contain a welded steel mounting plate. Includes 1" black screws and 1 1/2" adjustable glides. Available in two depths: 18" (actual) for a 24" deep work surface, and 24" (actual) for a 30" deep work surface.

SKU	DIMENSIONS	WEIGHT	PRICE (BU)	PAINTED PRICE*	COLOR OPTIONS
UI.0005.01.XX	27 3/4"H x 18"D	13 lbs	\$38.25	\$49.75	BU MT HT HF
UI.0005.02.XX	27 3/4"H x 24" D	15 lbs	\$43.50	\$55.00	LG LT PL SW

## O-LEG



### O-LEG

A welded 1" x 2" squared base with two 6" rhombus steel mounting plates on each end. Includes 1" black screws and 1 1/2" adjustable glides. Available in two depths: 24" and 30".

SKU	DIMENSIONS	WEIGHT	PRICE (BU)	PAINTED PRICE*	COLOR OPTIONS
UI.0023.24.XX	27 3/4"H x 24"D	16 lbs	\$61.75	\$73.25	BU MT HT HF
UI.0023.30.XX	27 3/4"H x 30"D	18 lbs	\$64.50	\$76.00	LG LT PL SW

\* PAINTED LEGS WILL REQUIRE A MINIMUM OF 8 TO BE ORDERED - 2 WEEK LEAD TIME  
\* IF LESS THAN 8 ORDERED, A \$60.00 UPCHARGE WILL BE ADDED TO YOUR ORDER

# CAFÉ HEIGHT LEGS + BARSTOOL

## CAFÉ HEIGHT TABLE LEGS



### 2" SINGLE PENINSULA LEG WITH GLIDES

SKU	UI.0004.08.XX
Dimensions	40 ¾"H x 2"W
Weight	9 lbs
Price (BU)	\$25.50
Painted Price*	\$37.00
Color Options	BU MT HT HF
	LG LT PL SW

A welded 2" tubular base with a 6" x 6" steel mounting plate. Includes 1" black screws and 1 ½" adjustable glides.



### 24" C-LEG WITH GLIDES

SKU	UI.0006.06.XX
Dimensions	40 ¾"H x 22"D
Weight	13 lbs
Price (BU)	\$42.50
Painted Price*	\$54.00
Color Options	BU MT HT HF
	LG LT PL SW

A welded 2" tubular base with a 6" x 8" steel mounting plate. Includes 1" black screws and 1 ½" adjustable glides.



### 24" T-LEG WITH GLIDES

SKU	UI.0007.06.XX
Dimensions	40 ¾"H x 22"D
Weight	13 lbs
Price (BU)	\$43.00
Painted Price*	\$54.50
Color Options	BU MT HT HF
	LG LT PL SW

A welded 2" tubular base with a 6" x 8" steel mounting plate. Includes 2" dual wheel caster with lock and 1" black screws.



### 36" ARCHED X-BASE

SKU	UI.0013.04.XX
Dimensions	40"H x 32"D
Weight	24 lbs
Price (BU)	\$70.00
Painted Price*	\$81.50
Color Options	BU MT HT HF
	LG LT PL SW

A welded 2" tubular arched X-Base with an 8" x 8" steel mounting plate. Includes 1" black screws and 1 ½" adjustable glides.

## BARSTOOL WITH SWIVEL SEAT



### BARSTOOL WITH SWIVEL SEAT

A black powder coated steel frame with black vinyl swivel seat cushions. The stools have a weight capacity of 300 pounds. Measurements include: 30" seat height, 42" back height, and 16" x 17" cushioned seat.

SKU	DIMENSIONS	WEIGHT	PRICE
UI.0070.01.BK	42"H x 16"W	32 lbs	\$85.00

\* PAINTED LEGS WILL REQUIRE A MINIMUM OF 8 TO BE ORDERED - 2 WEEK LEAD TIME  
 \* IF LESS THAN 8 ORDERED, A \$60.00 UPCHARGE WILL BE ADDED TO YOUR ORDER

# ATLAS



"ATLAS WAS GIVEN THE TASK OF HOLDING THE HEAVENS ON HIS SHOULDERS AS PUNISHMENT FROM ZEUS FOR LEADING THE TITANS IN THEIR BATTLE WITH THE OLYMPIAN GODS."

# ATLAS TABLE BASE

THE POWER LIFT TABLE THAT WON'T LET YOU DOWN  
...UNTIL YOU TELL IT TO



## ATLAS TABLE BASE

The Atlas Table Base features a telescoping frame that can support top sizes from 48" to 78" long and 24" to 30" deep. The base has a control module that is capable of memorizing three different heights. It also has the ability to reach a maximum height of 49.2". A built-in safety feature helps to avoid any injury to hands or fingers while base is in motion.



### STRAIGHT STYLE SPECIFICATIONS:

SKU	AT23.XX
Dimensions	48"-78"L x 24.5"-49.2"H x 24"-30"D
Price	\$605.00
Available Colors	Black (BK), White (WH), Silver (SVR)



YOU TOO CAN HARNESS THE POWER OF THE GREEK TITAN  
WITH THE ATLAS POWER LIFT TABLE

## BENEFITS OF A SIT/STAND WORK SURFACE

Having a sit/stand work surface offers many benefits to individuals. The Atlas Table Base can easily be adjusted to anyone's height for them to stand up comfortably while working. Standing while working can help burn calories, which in time, will help with weight loss. The Atlas Table Base is also beneficial to those who are diabetic. Studies have shown standing after lunch can help lower blood sugar levels. Along with lowering blood sugar levels, standing can help lower the risk of heart disease. Many workers generally sit throughout the entire day. If they do not have a quality chair, they may experience back pain. Our Atlas Table Base can help reduce back pain too!



### CORNER STYLE SPECIFICATIONS:

SKU	AT33.XX
Dimensions	48"-78"L x 24.5"-49.2"H x 24"-30"D
Price	\$990.00
Available Colors	Black (BK), White (WH), Silver (SVR)



# STORAGE SOLUTIONS



# PEDESTALS



## OPEN-TOP SUPPORT



### BOX - BOX - FILE

SKU	DEPTH	PRICE
U.0502.00.X.XX	18"	\$191.50
U.0502.01.X.XX	22"	\$195.75
U.0502.02.X.XX	28"	\$215.75

All pedestals are 27 1/2" high x 15" wide. Includes top channels to attach to the underside of a work surface. Ball-bearing drawer slides with quick disconnect and anti-rebound drawers. Leveling glides to allow 7/8" adjustment.



### FILE - FILE

SKU	DEPTH	PRICE
U.0501.00.X.XX	18"	\$177.50
U.0501.01.X.XX	22"	\$181.50
U.0501.02.X.XX	28"	\$202.00

All pedestals are 27 1/2" high x 15" wide. Includes top channels to attach to the underside of a work surface. Ball-bearing drawer slides with quick disconnect and anti-rebound drawers. Leveling glides to allow 7/8" adjustment.

## CLOSED-TOP SUPPORT



### BOX - BOX - FILE

SKU	DEPTH	PRICE
U.0504.00.X.XX	18"	\$198.75
U.0504.01.X.XX	22"	\$204.25
U.0504.02.X.XX	28"	\$226.00

All pedestals are 27 1/2" high x 15" wide. Ball-bearing drawer slides with quick disconnect and anti-rebound drawers. Leveling glides to allow 7/8" adjustment. Counterweights are included for added stability.



### FILE - FILE

SKU	DEPTH	PRICE
U.0503.00.X.XX	18"	\$184.25
U.0503.01.X.XX	22"	\$190.00
U.0503.02.X.XX	28"	\$213.00

All pedestals are 27 1/2" high x 15" wide. Ball-bearing drawer slides with quick disconnect and anti-rebound drawers. Leveling glides to allow 7/8" adjustment. Counterweights are included for added stability.

## MOBILE



### BOX - BOX - FILE

SKU	DEPTH	PRICE
U.0506.00.X.XX	18"	\$205.75
U.0506.01.X.XX	22"	\$213.00
U.0506.02.X.XX	28"	\$233.00

All pedestals are 27 1/2" high x 15" wide. Ball-bearing drawer slides with quick disconnect and anti-rebound drawers. Leveling glides to allow 7/8" adjustment. Will fit under most standard height work surfaces. Counterweight is included.



### FILE - FILE

SKU	DEPTH	PRICE
U.0505.00.X.XX	18"	\$191.50
U.0505.01.X.XX	22"	\$198.50
U.0505.02.X.XX	28"	\$220.00

All pedestals are 27 1/2" high x 15" wide. Ball-bearing drawer slides with quick disconnect and anti-rebound drawers. Leveling glides to allow 7/8" adjustment. Will fit under most standard height work surfaces. Counterweight is included.

\* NOTE: FOR COLOR OPTIONS, PLEASE VIEW REFERENCE PAGE 76  
\* FOR DRAWER PULL STYLES, VIEW PAGE 79

# PEDESTALS CONTINUED



## MOBILE CONTINUED

Mobile - 22"H  
Box - File



Mobile - 22"H  
Box - Box - Box



Cushioned Top - 24"H  
Box - File



Cushioned Top - 24"H  
Box - Box - Box



## HANGING PEDESTAL FILES

25" Hanging Pedestal  
Box - Box - File



25" Hanging Pedestal  
File - File



19" Hanging Pedestal  
Box - File



19" Hanging Pedestal  
Box - Box - Box



13" Hanging Pedestal  
Box - Box



13" Hanging Pedestal  
File



7" Hanging Pedestal  
Box



# PEDESTALS CONTINUED

## MOBILE - 22"H / CUSHIONED TOP MOBILE SPECS

Made in the USA from high quality, solid metal. All of our mobile and cushioned top mobile pedestals include four black plastic casters - 2 locking and 2 non-locking. The cushioned top pedestal contains a cushion that comes standard in a solid black polyester fabric (**other color options available on page 78**). Our mobile pedestals fit under most standard work surfaces. Counterweights are included for added stability to mobile pedestals.

PRODUCT DESCRIPTION	SKU	DEPTH	WIDTH	HEIGHT	PRICE
<b>MOBILE PEDESTAL</b>					
18" Box - File	U.0509.00.X.XX	18"	15"	22 3/8"	\$178.75
22" Box - File	U.0509.01.X.XX	22"	15"	22 3/8"	\$183.00
28" Box - File	U.0509.02.X.XX	28"	15"	22 3/8"	\$199.00
18" Box - Box - Box	U.0508.00.X.XX	18"	15"	22 3/8"	\$190.00
22" Box - Box - Box	U.0508.01.X.XX	22"	15"	22 3/8"	\$195.00
28" Box - Box - Box	U.0508.02.X.XX	28"	15"	22 3/8"	\$213.00
<b>CUSHIONED TOP PEDESTAL</b>					
18" Box - File	U.0509.CT.00.X.XX	18"	15"	24 1/8"	\$270.00
22" Box - File	U.0509.CT.01.X.XX	22"	15"	24 1/8"	\$275.75
18" Box - Box - Box	U.0508.CT.00.X.XX	18"	15"	24 1/8"	\$284.00
22" Box - Box - Box	U.0508.CT.01.X.XX	22"	15"	24 1/8"	\$290.00

## HANGING PEDESTAL FILES SPECS

Made in the USA from high quality, solid metal. Our hanging pedestals are available in four heights and two depths. They feature pre-drilled holes to be easily attached to any work surface.

PRODUCT DESCRIPTION	SKU	DEPTH	WIDTH	HEIGHT	PRICE
<b>25" HANGING PEDESTAL FILE</b>					
18" Box - Box - File	U.0519.00.X.XX	18"	15"	25 5/8"	\$189.00
22" Box - Box - File	U.0519.01.X.XX	22"	15"	25 5/8"	\$194.50
18" File - File	U.0518.00.X.XX	18"	15"	25 5/8"	\$174.50
22" File - File	U.0518.01.X.XX	22"	15"	25 5/8"	\$180.00
<b>19" HANGING PEDESTAL FILE</b>					
18" Box - File	U.0517.00.X.XX	18"	15"	19 5/8"	\$148.75
22" Box - File	U.0517.01.X.XX	22"	15"	19 5/8"	\$154.50
18" Box - Box - Box	U.0516.00.X.XX	18"	15"	19 5/8"	\$158.75
22" Box - Box - Box	U.0516.01.X.XX	22"	15"	19 5/8"	\$164.50
<b>13" HANGING PEDESTAL FILE</b>					
18" Box - Box	U.0515.00.X.XX	18"	15"	13 5/8"	\$138.75
22" Box - Box	U.0515.01.X.XX	22"	15"	13 5/8"	\$144.50
18" File	U.0514.00.X.XX	18"	15"	13 5/8"	\$128.75
22" File	U.0514.01.X.XX	22"	15"	13 5/8"	\$136.00
<b>7" HANGING PEDESTAL FILE</b>					
18" Box	U.0513.00.X.XX	18"	15"	7 5/8"	\$93.00
22" Box	U.0513.01.X.XX	22"	15"	7 5/8"	\$98.75

\* NOTE: FOR COLOR OPTIONS, PLEASE VIEW REFERENCE PAGE 76  
 \* FOR DRAWER PULL STYLES, VIEW PAGE 79

# LATERAL FILES



## 2-HIGH LATERAL FILE



### 2-HIGH LATERAL FILE FEATURES

Made in the USA from high quality, solid metal. Our 2-high lateral files feature two full-extension, steel ball-bearing, drawers with a safety interlock system to allow only one drawer to be open at a time. Leveling glides to allow 7/8" adjustment. The 2-high file is a free standing file with a lock, that will accommodate letter, legal, or A-4 filing. Counterweights are available if needed, but sold separately. Comes in the standard / full pull (other pull options available upon request). Available in three widths: 30", 36", and 42".

SKU	DEPTH	WIDTH	HEIGHT	PRICE
U.0522.30.X.XX	18"	30"	27 1/2"	\$283.00
U.0522.36.X.XX	18"	36"	27 1/2"	\$301.50
U.0522.42.X.XX	18"	42"	27 1/2"	\$331.50

## 3-HIGH LATERAL FILE

### 3-HIGH LATERAL FILE FEATURES

Made in the USA from high quality, solid metal. Our 3-high lateral files feature three full-extension, steel ball-bearing, drawers with a safety interlock system to allow only one drawer to be open at a time. Leveling glides to allow 7/8" adjustment. The 3-high file is a free standing file with a lock, that will accommodate letter, legal, or A-4 filing. Counterweights are available if needed, but sold separately. Comes in the standard / full pull (other pull options available upon request). Available in three widths: 30", 36", and 42".



SKU	DEPTH	WIDTH	HEIGHT	PRICE
U.0523.30.X.XX	18"	30"	39 1/2"	\$382.50
U.0523.36.X.XX	18"	36"	39 1/2"	\$407.50
U.0523.42.X.XX	18"	42"	39 1/2"	\$448.50

\* NOTE: FOR COLOR OPTIONS, PLEASE VIEW REFERENCE PAGE 76  
\*FOR DRAWER PULL STYLES, VIEW PAGE 79

# LATERAL FILES

## 4-HIGH LATERAL FILE



### 4-HIGH LATERAL FILE FEATURES

Made in the USA from high quality, solid metal. Our 4-high lateral files feature four full-extension, steel ball-bearing, drawers with a safety interlock system to allow only one drawer to be open at a time. Leveling glides to allow 7/8" adjustment. The 4-high file is a free standing file with a lock, that will accommodate letter, legal, or A-4 filing. Counterweights are available if needed, but sold separately. Comes in the standard / full pull (other pull options available upon request). Available in three widths: 30", 36", and 42".

SKU	DEPTH	WIDTH	HEIGHT	PRICE
U.0524.30.X.XX	18"	30"	51 1/2"	\$471.00
U.0524.36.X.XX	18"	36"	51 1/2"	\$502.00
U.0524.42.X.XX	18"	42"	51 1/2"	\$551.50

## 5-HIGH LATERAL FILE

### 5-HIGH LATERAL FILE FEATURES

Made in the USA from high quality, solid metal. Our 5-high lateral files feature four full-extension, steel ball-bearing, drawers with a safety interlock system to allow only one drawer to be open at a time. The top door flips up and recedes over the top of the lateral file, revealing a fixed shelf with 14" of clearance for the storage. Leveling glides to allow 7/8" adjustment. The 5-high file is a free standing file with a lock, that will accommodate letter, legal, or A-4 filing. Counterweights are available if needed, but sold separately. Comes in the standard / full pull (other pull options available upon request). Available in three widths: 30", 36", and 42".



SKU	DEPTH	WIDTH	HEIGHT	PRICE
U.0525.30.X.XX	18"	30"	67 3/8"	\$590.00
U.0525.36.X.XX	18"	36"	67 3/8"	\$629.00
U.0525.42.X.XX	18"	42"	67 3/8"	\$691.50

\* NOTE: FOR COLOR OPTIONS, PLEASE VIEW REFERENCE PAGE 76  
 \* FOR DRAWER PULL STYLES, VIEW PAGE 79

# LATERAL FILE COMBINATION



## STORAGE CABINET - LATERAL FILE COMBINATION



4-HIGH (FILE - FILE)  
One adjustable shelf



5-HIGH (FILE - FILE)  
Two adjustable shelves



5-HIGH (FILE - FILE - FILE)  
One adjustable shelf

## BOOKCASE - LATERAL FILE COMBINATION



4-HIGH (FILE - FILE)  
One adjustable shelf



5-HIGH (FILE - FILE)  
Two adjustable shelves



5-HIGH (FILE - FILE - FILE)  
One adjustable shelf

# LATERAL FILE COMBINATION

## STORAGE CABINET - LATERAL FILE FEATURES

Made in the USA from high quality, solid metal. Our storage cabinet - lateral files include two locks that are keyed alike. This combination offers supreme storage for more than just files. Great for large offices. The cabinet portion contains adjustable shelves to fit heights for binders or taller items. Available in three different widths: 30", 36", 42", along with a variety of heights. Please note: Counterweights are not included but strongly recommended.

PRODUCT DESCRIPTION	SKU	DEPTH	WIDTH	HEIGHT	PRICE
<b>4-HIGH STORAGE CABINET - LATERAL FILE COMBINATION</b>					
30" File - File	U.0555.30.X.XX	18"	30"	51 ½"	\$699.00
36" File - File	U.0555.36.X.XX	18"	36"	51 ½"	\$769.50
42" File - File	U.0555.42.X.XX	18"	42"	51 ½"	\$840.00
<b>5-HIGH STORAGE CABINET - LATERAL FILE COMBINATION</b>					
30" File - File	U.0556.30.X.XX	18"	30"	67 ¾"	\$800.00
36" File - File	U.0556.36.X.XX	18"	36"	67 ¾"	\$870.50
42" File - File	U.0556.42.X.XX	18"	42"	67 ¾"	\$961.50
30" File - File - File	U.0557.30.X.XX	18"	30"	67 ¾"	\$831.50
36" File - File - File	U.0557.36.X.XX	18"	36"	67 ¾"	\$911.00
42" File - File - File	U.0557.42.X.XX	18"	42"	67 ¾"	\$1,002.00

## BOOKCASE - LATERAL FILE FEATURES

Made in the USA from high quality, solid metal. Our bookcase - lateral files include two locks that are keyed alike. This combination offers supreme storage for more than just files. Great for large offices. The bookcase portion contains adjustable shelves to fit heights for binders or taller items. Available in three different widths: 30", 36", 42", along with a variety of heights. Please note: Counterweights are not included, but strongly recommended.

PRODUCT DESCRIPTION	SKU	DEPTH	WIDTH	HEIGHT	PRICE
<b>4-HIGH BOOKCASE- LATERAL FILE COMBINATION</b>					
30" File - File	U.0550.30.XX	18"	30"	51 ½"	\$627.50
36" File - File	U.0550.36.XX	18"	36"	51 ½"	\$678.50
42" File - File	U.0550.42.XX	18"	42"	51 ½"	\$759.00
<b>5-HIGH BOOKCASE - LATERAL FILE COMBINATION</b>					
30" File - File	U.0551.30.XX	18"	30"	68"	\$729.00
36" File - File	U.0551.36.XX	18"	36"	68"	\$790.00
42" File - File	U.0551.42.XX	18"	42"	68"	\$880.50
30" File - File - File	U.0552.30.XX	18"	30"	68"	\$770.00
36" File - File - File	U.0552.36.XX	18"	36"	68"	\$830.00
42" File - File - File	U.0552.42.XX	18"	42"	68"	\$921.50

\* NOTE: FOR COLOR OPTIONS, PLEASE VIEW REFERENCE PAGE 76  
 \* FOR DRAWER PULL STYLES, VIEW PAGE 79

# LATERAL FILE COMBINATION



## OPEN TOP SUPPORT COMBO CENTER

Made in the USA from high quality, solid metal. These lateral files feature open top channels to easily attach to any work surface. Available in three styles (shown below). Please note: Counterweights are not included.



BOX - BOX - FILE	
SKU	U.0526.6612.X.XX
DEPTH	18"
WIDTH	30"
HEIGHT	27 ½"
PRICE	\$457.50

FILE - BOX - BOX	
SKU	U.0526.1266.X.XX
DEPTH	18"
WIDTH	30"
HEIGHT	27 ½"
PRICE	\$457.50

FILE - FILE	
SKU	U.0526.1212.X.XX
DEPTH	18"
WIDTH	30"
HEIGHT	27 ½"
PRICE	\$436.00

## FREESTANDING COMBO CENTER

Made in the USA from high quality, solid metal. These lateral files feature a solid steel top. An interlocking bottom drawer is used with the top drawers to help prevent tipping. Available in three styles (shown below). Please note: Counterweights are included with this style to add stability.



BOX - BOX - FILE	
SKU	U.0527.6612.X.XX
DEPTH	18"
WIDTH	30"
HEIGHT	27 ½"
PRICE	\$547.50

FILE - BOX - BOX	
SKU	U.0527.1266.X.XX
DEPTH	18"
WIDTH	30"
HEIGHT	27 ½"
PRICE	\$547.50

FILE - FILE	
SKU	U.0527.1212.X.XX
DEPTH	18"
WIDTH	30"
HEIGHT	27 ½"
PRICE	\$524.50

\* NOTE: FOR COLOR OPTIONS, PLEASE VIEW REFERENCE PAGE 76  
\*FOR DRAWER PULL STYLES, VIEW PAGE 79

# VERTICAL FILES

## VERTICAL FILE FEATURES

Made in the USA from high quality, solid metal. Features include steel ball-bearing, drawers with a safety interlock system to allow only one drawer to be open at a time. All vertical files are 15" wide for letter-width filing. Our vertical files have double-wall drawer fronts and drawer sides. Counterweights are included for added stability. Leveling glides to allow 1" adjustment. Four styles to choose from (shown below).



PRODUCT DESCRIPTION	SKU	DEPTH	WIDTH	HEIGHT	PRICE
2-High Vertical File	U.0510.01.X.XX	28"	15"	27 ½"	\$322.00
3-High Vertical File	U.0510.02.X.XX	28"	15"	39 ½"	\$381.50
4-High Vertical File	U.0510.03.X.XX	28"	15"	51 ½"	\$454.50
5-High Vertical File	U.0510.04.X.XX	28"	15"	63 ½"	\$536.50

\* NOTE: FOR COLOR OPTIONS, PLEASE VIEW REFERENCE PAGE 76  
 \* FOR DRAWER PULL STYLES, VIEW PAGE 79

# STORAGE CABINETS



## 2-HIGH STORAGE CABINET



### 2-HIGH STORAGE CABINET FEATURES

Made in the USA from high quality, solid metal. Our 2-high storage cabinet features one adjustable shelf. Leveling glides to allow 1" adjustment. The cabinet includes concealed hinges to allow for easy-adjustment. Available in three standard widths: 30", 36", and 42" and two standard depths: 18" and 24".

SKU	DEPTH	WIDTH	HEIGHT	PRICE
U.0536.2830.XX	18"	30"	27 ½"	\$374.50
U.0536.2836.XX	18"	36"	27 ½"	\$382.00
U.0536.2842.XX	18"	42"	27 ½"	\$419.00
U.0537.2830.XX	24"	30"	27 ½"	\$486.00
U.0537.2836.XX	24"	36"	27 ½"	\$496.00
U.0537.2842.XX	24"	42"	27 ½"	\$544.50

## 3-HIGH STORAGE CABINET

### 3-HIGH STORAGE CABINET FEATURES

Made in the USA from high quality, solid metal. Our 3-high storage cabinet features two adjustable shelves. Shelving adjusts in ½" increments. Leveling glides to allow 1" adjustment. The cabinet includes concealed hinges to allow for easy-adjustment. Available in three standard widths: 30", 36", and 42" and two standard depths: 18" and 24".

SKU	DEPTH	WIDTH	HEIGHT	PRICE
U.0536.4030.XX	18"	30"	39 ½"	\$436.00
U.0536.4036.XX	18"	36"	39 ½"	\$450.50
U.0536.4042.XX	18"	42"	39 ½"	\$483.00
U.0537.4030.XX	24"	30"	39 ½"	\$567.50
U.0537.4036.XX	24"	36"	39 ½"	\$587.50
U.0537.4042.XX	24"	42"	39 ½"	\$627.50



\* NOTE: FOR COLOR OPTIONS, PLEASE VIEW REFERENCE PAGE 76  
\*FOR DRAWER PULL STYLES, VIEW PAGE 79

# STORAGE CABINETS CONTINUED

## 4-HIGH STORAGE CABINET



### 4-HIGH STORAGE CABINET FEATURES

Made in the USA from high quality, solid metal. Our 4-high storage cabinet features three adjustable shelves. Shelving adjusts in ½" increments. Leveling glides to allow 1" adjustment. The cabinet includes concealed hinges to allow for easy-adjustment. Available in three standard widths: 30", 36", and 42" and two standard depths: 18" and 24".

SKU	DEPTH	WIDTH	HEIGHT	PRICE
U.0536.5230.XX	18"	30"	51 ½"	\$526.50
U.0536.5236.XX	18"	36"	51 ½"	\$543.00
U.0536.5242.XX	18"	42"	51 ½"	\$584.50
U.0537.5230.XX	24"	30"	51 ½"	\$684.50
U.0537.5236.XX	24"	36"	51 ½"	\$709.00
U.0537.5242.XX	24"	42"	51 ½"	\$762.00

## 5-HIGH STORAGE CABINET

### 5-HIGH STORAGE CABINET FEATURES

Made in the USA from high quality, solid metal. Our 5-high storage cabinet includes four adjustable shelves. Shelving adjusts in ½" increments. Leveling glides to allow 1" adjustment. The cabinet includes concealed hinges to allow for easy-adjustment. Available in three standard widths: 30", 36", and 42" and two standard depths: 18" and 24".

SKU	DEPTH	WIDTH	HEIGHT	PRICE
U.0536.6730.XX	18"	30"	67 ¾"	\$616.00
U.0536.6736.XX	18"	36"	67 ¾"	\$634.50
U.0536.6742.XX	18"	42"	67 ¾"	\$685.00
U.0537.6730.XX	24"	30"	67 ¾"	\$749.00
U.0537.6736.XX	24"	36"	67 ¾"	\$760.50
U.0537.6742.XX	24"	42"	67 ¾"	\$818.00



\* NOTE: FOR COLOR OPTIONS, PLEASE VIEW REFERENCE PAGE 76  
 \* FOR DRAWER PULL STYLES, VIEW PAGE 79

# TOWERS



## BOOKCASE TOWERS



### BOOKCASE TOWER FEATURES

Made in the USA from high quality, solid metal. This solid bookcase tower includes heavy-gauge top, bottom, and shelves. Our bookcase towers feature adjustable shelves in ½" increments. Leveling glides to allow 1" adjustment. The tower includes concealed hinges to allow for easy adjustment. Available in two standard heights: 51 ½" and 63 ½".

• **NOTE:** Right (R) and Left (L) indicate the direction the bookcase is facing.

SKU	BOX/FILE	DEPTH	WIDTH	HEIGHT	PRICE
<b>4-HIGH BOOKCASE TOWERS (ONE ADJUSTABLE SHELF)</b>					
U.0575.02L.X.XX	Box - Box - File	24"	15"	51 ½"	\$490.00
U.0575.01L.X.XX	File - File	24"	15"	51 ½"	\$474.50
U.0575.02R.X.XX	Box - Box - File	24"	15"	51 ½"	\$490.00
U.0575.01R.X.XX	File - File	24"	15"	51 ½"	\$474.50
<b>5-HIGH BOOKCASE TOWERS (TWO ADJUSTABLE SHELVES)</b>					
U.0576.02L.X.XX	Box - Box - File	24"	15"	63 ½"	\$534.50
U.0576.01L.X.XX	File - File	24"	15"	63 ½"	\$519.00
U.0576.02R.X.XX	Box - Box - File	24"	15"	63 ½"	\$534.50
U.0576.01R.X.XX	File - File	24"	15"	63 ½"	\$519.00

## CUPBOARD TOWERS



### CUPBOARD TOWER FEATURES

Made in the USA from high quality, solid metal. This solid cupboard tower includes heavy-gauge top, bottom, and shelves. Leveling glides to allow 1" adjustment. The tower includes concealed hinges to allow for easy adjustment. Cabinet includes two locks that are keyed alike. Available in two standard heights: 51 ½" and 63 ½".

• **NOTE:** Right (R) and Left (L) indicate the hinge location for the cupboard door

SKU	BOX/FILE	DEPTH	WIDTH	HEIGHT	PRICE
<b>4-HIGH CUPBOARD TOWERS (ONE ADJUSTABLE SHELF)</b>					
U.0565.02L.X.XX	Box - Box - File	24"	15"	51 ½"	\$530.50
U.0565.01L.X.XX	File - File	24"	15"	51 ½"	\$514.50
U.0565.02R.X.XX	Box - Box - File	24"	15"	51 ½"	\$530.50
U.0565.01R.X.XX	File - File	24"	15"	51 ½"	\$514.50
<b>5-HIGH CUPBOARD TOWERS (TWO ADJUSTABLE SHELVES)</b>					
U.0566.02L.X.XX	Box - Box - File	24"	15"	63 ½"	\$575.00
U.0566.01L.X.XX	File - File	24"	15"	63 ½"	\$559.00
U.0566.02R.X.XX	Box - Box - File	24"	15"	63 ½"	\$575.00
U.0566.01R.X.XX	File - File	24"	15"	63 ½"	\$559.00

\* **NOTE: FOR COLOR OPTIONS, PLEASE VIEW REFERENCE PAGE 76**  
\***FOR DRAWER PULL STYLES, VIEW PAGE 79**

# TOWERS CONTINUED

## WARDROBE - BOOKCASE TOWERS



### WARDROBE - BOOKCASE TOWER FEATURES

Made in the USA from high quality, solid metal. This solid wardrobe - bookcase tower includes heavy-gauge top, bottom, and shelves. This style includes a side-to-side coat rod for hanging jackets, sweaters, etc. Our wardrobe bookcase towers feature adjustable shelves in ½" increments. Leveling glides to allow 1" adjustment. The tower includes concealed hinges to allow for easy adjustment. Available in two standard heights: 51 ½" and 63 ½".

• **NOTE:** Right (R) and Left (L) indicate which side the coat closet is

SKU	BOX/FILE	DEPTH	WIDTH	HEIGHT	PRICE
<b>4-HIGH WARDROBE - BOOKCASE TOWERS (ONE ADJUSTABLE SHELF)</b>					
U.0570.02L.X.XX	Box - Box - File	24"	24"	51 ½"	\$769.50
U.0570.01L.X.XX	File - File	24"	24"	51 ½"	\$753.00
U.0570.02R.X.XX	Box - Box - File	24"	24"	51 ½"	\$769.50
U.0570.01R.X.XX	File - File	24"	24"	51 ½"	\$753.00
<b>5-HIGH WARDROBE - BOOKCASE TOWERS (TWO ADJUSTABLE SHELVES)</b>					
U.0571.02L.X.XX	Box - Box - File	24"	24"	63 ½"	\$870.50
U.0571.01L.X.XX	File - File	24"	24"	63 ½"	\$854.50
U.0571.02R.X.XX	Box - Box - File	24"	24"	63 ½"	\$870.50
U.0571.01R.X.XX	File - File	24"	24"	63 ½"	\$854.50

## WARDROBE - CUPBOARD TOWERS



### WARDROBE - CUPBOARD TOWER FEATURES

Made in the USA from high quality, solid metal. This solid wardrobe - cupboard tower includes heavy-gauge top, bottom, and shelves. This style includes a side-to-side coat rod. Three locks are included. Our wardrobe towers feature adjustable shelves in ½" increments. Leveling glides to allow 1" adjustment. The tower includes concealed hinges to allow for easy adjustment. Available in two standard heights: 51 ½" and 63 ½".

• **NOTE:** Right (R) and Left (L) indicate which side the coat closet is

SKU	BOX/FILE	DEPTH	WIDTH	HEIGHT	PRICE
<b>4-HIGH WARDROBE - CUPBOARD TOWERS (ONE ADJUSTABLE SHELF)</b>					
U.0560.02L.X.XX	Box - Box - File	24"	15"	51 ½"	\$810.00
U.0560.01L.X.XX	File - File	24"	15"	51 ½"	\$793.50
U.0560.02R.X.XX	Box - Box - File	24"	15"	51 ½"	\$810.00
U.0560.01R.X.XX	File - File	24"	15"	51 ½"	\$793.50
<b>5-HIGH WARDROBE - CUPBOARD TOWERS (TWO ADJUSTABLE SHELVES)</b>					
U.0561.02L.X.XX	Box - Box - File	24"	15"	63 ½"	\$890.50
U.0561.01L.X.XX	File - File	24"	15"	63 ½"	\$874.50
U.0561.02R.X.XX	Box - Box - File	24"	15"	63 ½"	\$890.50
U.0561.01R.X.XX	File - File	24"	15"	63 ½"	\$874.50

\* **NOTE:** FOR COLOR OPTIONS, PLEASE VIEW REFERENCE PAGE 76  
 \* **FOR DRAWER PULL STYLES, VIEW PAGE 79**

# TOWERS CONTINUED



## MOBILE WARDROBE - BOOKCASE TOWERS



### MOBILE WARDROBE - BOOKCASE TOWER FEATURES

Made in the USA from high quality, solid metal. This solid wardrobe - bookcase tower includes heavy-gauge top, bottom, and shelves. Wardrobe includes a side-to-side coat rod to hang jackets, sweaters, etc. Casters are included (2 locking, 2 non-locking). The tower includes concealed hinges to allow for easy adjustment. Wardrobe includes two locks that are keyed alike.

• **NOTE:** Right (R) and Left (L) indicate which side the coat closet is

SKU	BOX/FILE	DEPTH	WIDTH	HEIGHT	PRICE
U.0572.02L.X.XX	Box - Box - File	24"	24"	55 ½"	\$870.50
U.0572.01L.X.XX	File - File	24"	24"	55 ½"	\$854.50
U.0572.02R.X.XX	Box - Box - File	24"	24"	55 ½"	\$870.50
U.0572.01R.X.XX	File - File	24"	24"	55 ½"	\$854.50

## MOBILE WARDROBE - CUPBOARD TOWERS



### MOBILE WARDROBE - CUPBOARD TOWER FEATURES

Made in the USA from high quality, solid metal. This solid wardrobe - cupboard tower includes heavy-gauge top, bottom, and shelves. Wardrobe includes a side-to-side coat rod to hang jackets, sweaters, etc. Casters are included (2 locking, 2 non-locking). The tower includes concealed hinges to allow for easy adjustment. Wardrobe includes two locks that are keyed alike.

• **NOTE:** Right (R) and Left (L) indicate which side the coat closet is

SKU	BOX/FILE	DEPTH	WIDTH	HEIGHT	PRICE
U.0562.02L.X.XX	Box - Box - File	24"	15"	55 ½"	\$890.50
U.0562.01L.X.XX	File - File	24"	15"	55 ½"	\$874.50
U.0562.02R.X.XX	Box - Box - File	24"	15"	55 ½"	\$890.50
U.0562.01R.X.XX	File - File	24"	15"	55 ½"	\$874.50

\* **NOTE: FOR COLOR OPTIONS, PLEASE VIEW REFERENCE PAGE 76**  
\***FOR DRAWER PULL STYLES, VIEW PAGE 79**

# BOOKCASES

## BOOKCASE FEATURES

Made in the USA from high quality, solid metal. Features include side panels with double-wall construction. Sturdy shelves that adjust  $\frac{1}{2}$ " increments to fit any binder or book height. Leveling glides at the bottom of the bookcases to allow  $\frac{3}{4}$ " adjustment. Bookcases are great for any office to help organize and neatly display company binders, folders, etc. Our bookcases come in four standard heights and three standard widths (shown below).



PRODUCT DESCRIPTION	SKU	DEPTH	WIDTH	HEIGHT	PRICE
<b>2-HIGH BOOKCASES</b>					
30" 2-High Bookcase	U.0542.2830.XX	14"	30"	27 ½"	\$210.00
36" 2-High Bookcase	U.0542.2836.XX	14"	36"	27 ½"	\$221.50
42" 2-High Bookcase	U.0542.2842.XX	14"	42"	27 ½"	\$230.50
<b>3-HIGH BOOKCASES</b>					
30" 3-High Bookcase	U.0542.4030.XX	14"	30"	39 ½"	\$234.00
36" 3-High Bookcase	U.0542.4036.XX	14"	36"	39 ½"	\$244.50
42" 3-High Bookcase	U.0542.4042.XX	14"	42"	39 ½"	\$255.00
<b>4-HIGH BOOKCASES</b>					
30" 4-High Bookcase	U.0542.5230.XX	14"	30"	51 ½"	\$260.00
36" 4-High Bookcase	U.0542.5236.XX	14"	36"	51 ½"	\$270.50
42" 4-High Bookcase	U.0542.5242.XX	14"	42"	51 ½"	\$281.50
<b>5-HIGH BOOKCASES</b>					
30" 5-High Bookcase	U.0542.6830.XX	14"	30"	68"	\$288.00
36" 5-High Bookcase	U.0542.6836.XX	14"	36"	68"	\$299.00
42" 5-High Bookcase	U.0542.6842.XX	14"	42"	68"	\$309.00

\* NOTE: FOR COLOR OPTIONS, PLEASE VIEW REFERENCE PAGE 76

# OPEN PLAN STORAGE



## OPEN PLAN STORAGE FEATURES

Unisource Parts now supplies Open Plan storage options. Our Open Plan cabinets work well for the storage needs of collaborative work spaces as they provide a concealed solution. These cabinets are sold with steel tops to give them a polished look (prices shown include unit with steel top). Units can also be conjoined together under a laminate top (sold separately).

## OPEN PLAN LATERAL FILES



### SQUARE LEGS LATERAL FILE

Made in the USA from high quality, solid metal. This lateral file features square legs. Included in the lateral file are counterweights to add stability and two file bars in the bottom drawer for side-to-side filing. Our lateral files feature a safety interlock system which allows only one drawer to be opened at a time. Includes 1" adjustable glides. Available in three widths.

SKU	HEIGHT	WIDTH	DEPTH	PRICE
U.0580.30.X.XX	23"	30"	18"	\$494.00
U.0580.36.X.XX	23"	36"	18"	\$516.00
U.0580.42.X.XX	23"	42"	18"	\$547.00

### ROUND LEGS LATERAL FILE

Made in the USA from high quality, solid metal. This lateral file features round legs. Included in the lateral file are counterweights to add stability and two file bars in the bottom drawer for side-to-side filing. Our lateral files feature a safety interlock system which allows only one drawer to be opened at a time. Round legs have an adjustable height up to 1". Available in three widths.



SKU	HEIGHT	WIDTH	DEPTH	PRICE
U.0581.30.X.XX	23"	30"	18"	\$494.00
U.0581.36.X.XX	23"	36"	18"	\$516.00
U.0581.42.X.XX	23"	42"	18"	\$547.00

**\* NOTE: FOR COLOR OPTIONS, PLEASE VIEW REFERENCE PAGE 76  
\*FOR DRAWER PULL STYLES, VIEW PAGE 79**

# OPEN PLAN STORAGE

## OPEN PLAN BOOKCASES



### SQUARE LEGS BOOKCASE

Made in the USA from high quality, solid metal. This bookcase features square legs and one adjustable shelf. The bookcase includes cutouts to easily connect to adjacent cabinets. Includes 1" adjustable glides. Available in five widths.

SKU	HEIGHT	WIDTH	DEPTH	PRICE
U.0582.18.XX	23"	18"	17 1/8"	\$341.00
U.0582.24.XX	23"	24"	17 1/8"	\$360.00
U.0582.30.XX	23"	30"	17 1/8"	\$370.00
U.0582.36.XX	23"	36"	17 1/8"	\$391.50
U.0582.42.XX	23"	42"	17 1/8"	\$418.50

### ROUND LEGS BOOKCASE

Made in the USA from high quality, solid metal. This bookcase features round legs and one adjustable shelf. The bookcase includes cutouts to easily connect to adjacent cabinets. Includes 1" adjustable glides. Available in five widths.

SKU	HEIGHT	WIDTH	DEPTH	PRICE
U.0583.18.XX	23"	18"	17 1/8"	\$341.00
U.0583.24.XX	23"	24"	17 1/8"	\$360.00
U.0583.30.XX	23"	30"	17 1/8"	\$370.00
U.0583.36.XX	23"	36"	17 1/8"	\$391.50
U.0583.42.XX	23"	42"	17 1/8"	\$418.50



## WORK SURFACE LEGS



### SQUARE DESK LEG

SKU	PRICE
U.0588.01.TS	\$67.50

A 2" square tube with a textured silver finish. Includes 1" adjustable glides. Total leg height stands 27 5/8" tall with glides fully recessed.



### ROUND DESK LEG

SKU	PRICE
U.0589.01.NK	\$67.50

A steel leg with a brushed nickel finish. Leg height adjustable between 27 5/8" and 28 1/8".

\* NOTE: FOR COLOR OPTIONS, PLEASE VIEW REFERENCE PAGE 76

# OVERHEAD STORAGE



## METAL FLIPPER UNIT



### METAL FLIPPER UNIT FEATURES

Made in the USA from high quality, solid metal, overhead flipper unit with a door that recedes over the top of the unit.

SKU	DEPTH	WIDTH	HEIGHT	PRICE
U.0303.24.XX.X	13 ½"	24"	15"	\$206.00
U.0303.30.XX.X	13 ½"	30"	15"	\$206.50
U.0303.36.XX.X	13 ½"	36"	15"	\$215.00
U.0303.42.XX.X	13 ½"	42"	15"	\$225.00
U.0303.48.XX.X	13 ½"	48"	15"	\$237.00
U.0303.54.XX.X	13 ½"	54"	15"	\$287.50
U.0303.60.XX.X	13 ½"	60"	15"	\$298.00

## METAL FULL-HEIGHT SHELF



### METAL FULL-HEIGHT SHELF SPECS

Made in the USA from high quality, solid metal, overhead shelf unit with ends.

SKU	DEPTH	WIDTH	HEIGHT	PRICE
U.0305.24.XX.X	13 ½"	24"	15"	\$93.50
U.0305.30.XX.X	13 ½"	30"	15"	\$97.50
U.0305.36.XX.X	13 ½"	36"	15"	\$101.50
U.0305.42.XX.X	13 ½"	42"	15"	\$105.50
U.0305.48.XX.X	13 ½"	48"	15"	\$109.50
U.0305.54.XX.X	13 ½"	54"	15"	\$121.50
U.0305.60.XX.X	13 ½"	60"	15"	\$126.00

## METAL HALF-HEIGHT SHELF



### METAL HALF-HEIGHT SHELF SPECS

Made in the USA from high quality, solid metal, overhead shelf unit with ends.

SKU	DEPTH	WIDTH	HEIGHT	PRICE
U.0306.24.XX.X	13 ½"	24"	7"	\$89.50
U.0306.30.XX.X	13 ½"	30"	7"	\$93.50
U.0306.36.XX.X	13 ½"	36"	7"	\$97.50
U.0306.42.XX.X	13 ½"	42"	7"	\$101.50
U.0306.48.XX.X	13 ½"	48"	7"	\$105.50
U.0306.54.XX.X	13 ½"	54"	7"	\$117.50
U.0306.60.XX.X	13 ½"	60"	7"	\$121.50

**\* NOTE: FOR ALL OVERHEAD STORAGE UNITS, PLEASE CLARIFY THE STYLE OF SYSTEM THE UNIT IS ATTACHING TO (HERMAN MILLER ACTION OFFICE, HAWORTH UNIGROUP OR PREMISE, STEELCASE AVENIR, KNOLL DIVIDENDS OR MORRISON).**

**\* NOTE: FOR COLOR OPTIONS, PLEASE VIEW REFERENCE PAGE 76**

# STORAGE ACCESSORIES

## PEDESTAL FILE ACCESSORIES



### DRAWER DIVIDER

<b>SKU</b>	U.0540.02.BK
<b>Price</b>	\$5.00

Black, plastic, drawer divider used to compartmentalize pedestal box drawers.



### HANGING FILE BAR

<b>SKU</b>	U.0540.03.BK
<b>Price</b>	\$3.75 / pair

Black, plastic, hanging file bars to allow side-to-side filing. Offered in pairs.



### PENCIL TRAY

<b>SKU</b>	U.0540.01.BK
<b>Price</b>	\$5.00

Black, plastic, pencil tray used to store pencils, pens, paper clips, rubber bands, etc.

## LATERAL FILE / BOOKCASE ACCESSORIES



### SHELF DIVIDER

<b>SKU</b>	U.0541.01.BK
<b>Price</b>	\$32.50 / pkg of 3

Package of three 7 1/2" high, 8" wide, magnetic dividers. Made from 18-gauge steel with a black powder coat finish.



### MAGNETIC LABEL

<b>SKU</b>	U.0540.04.00
<b>Price</b>	\$12.50 / pkg of 10

Magnetic label ready to use for all size and style of drawer fronts. 3" x 1" clear plastic label with card stock insert.

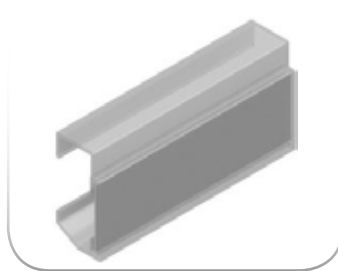

### DRAWER LABEL

<b>SKU</b>	U.0540.05.00
<b>Price</b>	\$12.50 / pkg of 10

Label for self-handled drawer fronts. 3" x 1" clear plastic label with card stock insert.

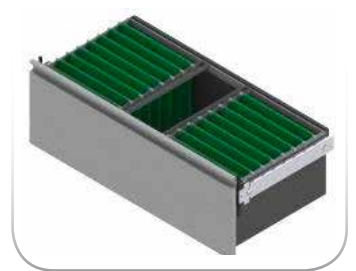

### HANGING FILE BAR

<b>SKU</b>	U.0541.05.BK
<b>Price</b>	\$11.00 / pkg of 4

Used for conversion, to allow front-to-back filing. Package of four. One set needed per lateral file drawer.

## LATERAL FILE ACCESSORIES - COUNTERWEIGHTS

To ensure a storage unit's stability, we recommend a counterweight if the unit is not being anchored to a wall or the ground, or anchored to another unit.

The storage units listed below DO NOT include counterweights, and thus must be purchased separately for stability:

- Lateral Files
- Storage Cabinet-Lateral Files
- Bookcase-Lateral Files

PRODUCT DESCRIPTION	SKU	WEIGHT	PRICE
2-High Counterweight	U.0541.05.2H	50 lbs	\$56.00
3-High Counterweight	U.0541.05.3H	50 lbs	\$56.00
4-High Counterweight	U.0541.05.4H	35 lbs	\$42.50
5-High Counterweight	U.0541.05.5H	35 lbs	\$42.50

# UNIVERSAL PRODUCTS



# SPRAY PAINT

## TOUCH-UP SPRAY PAINT

High quality touch-up paint for Herman Miller, Haworth, and Steelcase colors. Compatible with most OEM finishes. Solvent based paint. Adequate ventilation is required when using this product. Professional touch-up only. Painting should be done by a professional to ensure quality. All finishes should be tested prior to use to make sure they are applicable to the field conditions. **FLAMMABLE** product! Do not use near open flame or pilot light.

NOTE: Product can only be shipped UPS Ground



## HERMAN MILLER COLORS

PRODUCT DESCRIPTION	SKU	PRICE	COLOR OPTIONS				
A. BLACK UMBER (BU)	U.0120.01.BU	\$11.75		A.	B.	C.	D.
B. DARK TONE (DT)	U.0120.01.DT	\$11.75					
C. INNERTONE LIGHT (HF)	U.0120.01.HF	\$11.75					
D. INNERTONE (HT)	U.0120.01.HT	\$11.75					
E. LIGHT GREY (LG)	U.0120.01.LG	\$11.75					
F. LIGHT TONE (LT)	U.0120.01.LT	\$11.75					
G. MEDIUM TONE (MT)	U.0120.01.MT	\$11.75					

## HAWORTH (HW) + STEELCASE (SC) COLORS

PRODUCT DESCRIPTION	SKU	PRICE	COLOR OPTIONS				
A. HW CHARCOAL (CH)	U.0120.01.CH	\$13.50		A.	B.	C.	D.
B. HW GRAPHITE (GR)	U.0120.01.GR	\$13.50					
C. HW GREYSTONE (GT)	U.0120.01.GT	\$13.50					
D. HW PLATINUM (PL)	U.0120.01.PL	\$13.50					
E. HW SMOKE (SM)	U.0120.01.SM	\$13.50					
F. SC GREY VALUE 1 (GV1)	U.0120.01.GV1	\$13.50					
G. SC GREY VALUE 2 (GV2)	U.0120.01.GV2	\$13.50					
H. SC WARM BROWN 1 (WB1)	U.0120.01.WB1	\$13.50					

# LIGHTING

## FLUORESCENT LIGHTING



### FLUORESCENT TASK LIGHT

SKU	Actual Length	Price
U.0024.36.BU	22.91"	\$39.25
U.0024.48.BU	34.71"	\$52.00
U.0024.60.BU	46.51"	\$58.50

Please Note:

- For a 30" or 36" shelf, we recommend the U.0024.36.BU light
- For a 42" or 48" shelf, we recommend the U.0024.48.BU light
- For a 60" shelf, we recommend the U.0024.60.BU light

## LED LIGHTING



### LED DESK LAMP

SKU	UI.0043.01.AL
Price	\$88.50

3-step brightness control. Light does not build heat and is mercury free. Lifetime is about double that of a fluorescent light. Incandescent equivalent is 80 watts.



### 24" LED LIGHT KIT

SKU	UI.0043.24.AL
Price	\$83.25

Kit includes one UI.0040.24 task light and one UI.0041.01 power pack. 6" and 19" daisy chains available (sold separately), can daisy chain up to four lights on one power pack.



### 24" LED TASK LIGHT

SKU	UI.0040.24.AL
Price	\$48.75

Easy to install via magnet or screws. Light does not build heat and is mercury free. Lifetime is about double that of a fluorescent light. Incandescent equivalent is 80 watts.



### LED TASK LIGHT POWER SUPPLY

SKU	Length	Price
UI.0041.01.00	72"	\$34.50

Used to power the 24" LED Task Light. The cord length measures 6 feet (72").



### LED TASK LIGHT CONNECTION CORD

SKU	Length	Price
UI.0042.06.00	6"	\$3.00
U.0042.19.00	19"	\$5.00

Used to connect additional LED task lights to a single power supply.



### 48" TASK LIGHT CORD MANAGER

SKU	U.0168.01.BK
Price	\$3.50

48" plastic railing unit to hold the power cord for task lights. Has mounting tape that can attach to almost any flat surface.

# LED LIGHTING

## SMART TOUCH LED DESK LAMP



### SMART TOUCH LED DESK LAMP

SKU	Height	Color	Price
UI.0043.02.BK	16.53"	Black	\$128.25
UI.0043.02.WH	16.53"	White	\$128.25

Made from eco-friendly, light weight aluminum, our new smart touch LED desk lamp features a brightness and color temperature control. The smart touch pad located at the bottom of the lamp makes it easy to increase or decrease brightness along with changing the light color from warm white to daylight. The LED desk lamp also has a one-hour timer and the ability to remember your brightness and color choice. With a swivel light and compactible size, this lamp is portable and will bring light to any area.

## UNDER SHELF LED TASK LIGHT



### UNDER SHELF LED TASK LIGHT

SKU	Actual Length	Price
U.0025.24.BK	18.20"	\$75.25
U.0025.42.BK	36.20"	\$90.75

Made from 20 gauge steel, our new LED task light features a 9ft black cord with a powder coat finish. Included with the task light is a set of mounting rails for metal shelves.

Please Note:

- For a 24", 30", or 36" shelf, we recommend the U.0025.24.BK light
- For a 42", 48", or 60" shelf, we recommend the U.0025.42.BK light

## INTEGRATED LED LIGHT

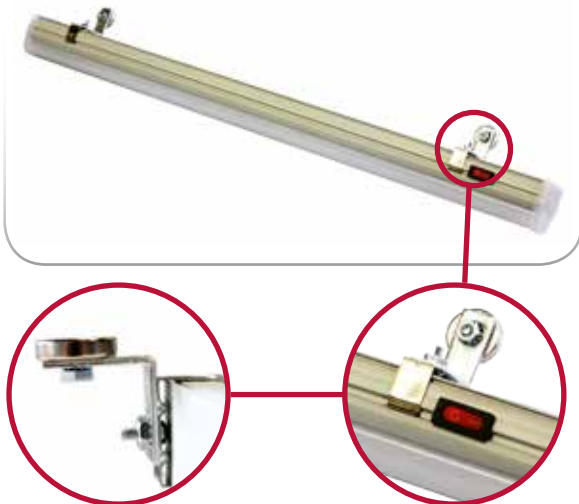

### INTEGRATED LED TASK LIGHT

SKU	Actual Length	Price
U.0026.24.WH	21.50"	\$46.50
U.0026.36.WH	33.45"	\$56.50
U.0026.48.WH	45.50"	\$65.00

Made from light weight aluminum, these LED task lights can be used for essentially any application. This task light includes strong magnetic mounting clips for attaching to any metal surface (mounting clips and hardware included to attach to wooden shelves).

Please Note:

- For a 24" or 30" shelf, we recommend the U.0026.24.WH light
- For a 36" or 42" shelf, we recommend the U.0026.36.WH light
- For a 48" or 60" shelf, we recommend the U.0026.48.WH light

# WORK SURFACE PRODUCTS

## UNIVERSAL WORK SURFACE PRODUCTS

Our universal products work with any work surface. They can be used with Herman Miller, Steelcase, Knoll, and many other systems.



### PLASTIC PENCIL DRAWER

SKU	U.0159.01.BK
Dimensions	16.25"D x 23"W
Price	\$19.25

Drawer used to organize pencils, pens, notes, and other products under a work surface. Four compartment molded drawer with a ball bearing suspension. Includes brackets and mounting screws to attach it to a wood core top.



### METAL PENCIL DRAWER

SKU	U.0159.02.BK
Dimensions	17 <sup>1</sup> / <sub>8</sub> "D x 19 <sup>1</sup> / <sub>8</sub> "W
Price	\$93.00

Made in the USA. High quality metal drawer used to organize pencils, pens, notes, and other products under a work surface. Drawer features lock, full extension, and ball bearing suspension.



### KEYBOARD TRAY

SKU	U.0603.01.BK
Keyboard Size	8 <sup>1</sup> / <sub>2</sub> "D x 20"W
Mouse Pad Size	7 <sup>1</sup> / <sub>4</sub> "D x 7 <sup>1</sup> / <sub>4</sub> "W
Price	\$126.50

Keyboard tray contains wrist rest for added comfort while typing. Wrist rest also helps to keep arms elevated. Mouse pad is connected to the tray for easy access and has a 270 degree swivel around the vertical axis.



### METAL COAT HOOK

SKU	U.0204.01.BK
Price	\$6.00

Steel painted coat hook for use in panel slots. Black finish. Works with 1" centered systems including Steelcase, Herman Miller, and others.



### 9" SUPPORT ARM

SKU	U.0147.01.BK
Price	\$24.25 / pair
Painted Price*	\$35.75 / pair

Color Options	BU	MT	HT	HF
	LG	LT		

Steel, 9" deep support arm used to support work surfaces. Sold in pairs.



### 18" SUPPORT ARM

SKU	U.0201.18.BK
Price	\$19.25 / pair
Painted Price*	\$30.75 / pair

Color Options	BU	MT	HT	HF
	LG	LT		

Steel cantilever support arm for use with many 1" centered OEM systems. 18" deep support arm with a universal 1" centered tooth pattern. Sold in pairs.



### SHARED SUPPORT BRACKET

SKU	U.0201.SB.BK
Price	\$3.00
Painted Price*	\$11.00

Color Options	BU	MT	HT	HF
	LG	LT		

Steel universal cantilever shared work surface adapter for U.0201.18.BK. Pricing is for each individual one. One is needed to create a shared application. Insert into angled slots on arm to allow for use as a shared support bracket.



### CORNER WORK SURFACE BRACKET

SKU	U.0201.CB.BK
Price	\$2.25 / pair

Steel corner work surface bracket for use with the U.0201.18.BK universal support arms. Black finish. Sold in pairs.

\* PAINTED SUPPORT ARMS + BRACKETS REQUIRE A MINIMUM OF 20 TO BE ORDERED - 2 WEEK LEAD TIME  
\* IF LESS THAN 20 ORDERED, A \$60.00 UPCHARGE WILL BE ADDED TO YOUR ORDER

# WORK SURFACE PRODUCTS CONT'



## GROMMET COVER

SKU	U.0031.03.BK
Price	\$1.25

Black, plastic cover with 2 pieces (cap and insert). Requires a 2.5" round hole.



## FLAT PLATE

SKU	U.0032.02.BK
Dimensions	2" x 5"

**Price** \$2.00  
Steel, flat, mounting plate with a black finish. For use with work surfaces or counter caps to help level surface to surface. Requires mounting screws (sold separately).



## DIVIDER CLAMP

SKU	UI.0100.01.XX
Price	\$10.00

**Color Options** BU MT  
Steel painted panel divider clamps with attaching hardware. Used to hold ¼" thick dividers. Works with all systems. Minimum of TWO sets of clamps per divider.



## WORK SURFACE SCREW

SKU	U.0011.02.ZI
Price	\$0.05

Pan head Phillips screw. Zinc plated. Various uses for systems, cubicles, case goods, tables, etc.



## TACK / MARKER BOARD CLIP

SKU	U.0022.01.GA
Price	\$6.50 / pair

Will attach to most 1" centered tooth systems to attach tack or marker boards to panels. Use with tack / marker board screw or standard screw.



## TACK / MARKER BOARD SCREW

SKU	U.0023.01.ZI
Price	\$0.05

Works in conjunction with lateral file clips (M.0181.01.DT) and the tack / marker board clip (U.0022.01.GA).



## Z-CLIP

SKU	Length	Price
U.0143.01.00	1.5"	\$1.25
U.0143.48.UP	4'	\$16.00

Used to attach tack or marker board to panel or wall. Must use at least TWO 1.5" Z-Clips to lock board to surface. NOTE: 4' Z-Clip do not contain holes.



## WORK SURFACE MOUNTED POWER MODULE

SKU	U.0050.02.BK
Price	\$65.00

Note: Surge Protected, with 6' cord, requires 2.75" x 5.95" hole with ¼" radius corners in work surface for mounting.

## STEEL MODESTY PANEL

Universal steel modesty panel for use with leg applications.

Note: C-Legs and Fan C-Legs come with predrilled holes for use with a modesty panel.



\* Painted panels will require a minimum quantity of 10 to be ordered. 2 week lead time. If less than 10 ordered, a \$60.00 upcharge will be added to your order

PRODUCT DESCRIPTION	SKU	HEIGHT	WIDTH	PRICE (BU)	PAINTED PRICE*	COLOR OPTIONS
36" Modesty Panel	U.0180.36.XX	9"	25"	\$30.00	\$48.50	BU MT
42" Modesty Panel	U.0180.42.XX	9"	31"	\$35.00	\$53.50	
48" Modesty Panel	U.0180.48.XX	9"	37"	\$45.00	\$63.50	HT HF
60" Modesty Panel	U.0180.60.XX	9"	49"	\$82.00	\$100.50	
66" Modesty Panel	U.0180.66.XX	9"	55"	\$84.00	\$102.50	LG LT
72" Modesty Panel	U.0180.72.XX	9"	61"	\$90.00	\$108.50	
84" Modesty Panel	U.0180.84.XX	9"	73"	\$95.00	\$113.50	PL SW
96" Modesty Panel	U.0180.96.XX	9"	85"	\$100.00	\$118.50	

# WALL MOUNTING STRIPS

## WALL MOUNTING STRIPS

Used to attach metal shelf units, tool bars, tack board, coat hangers, and many other units to either drywall or solid wall surfaces. Herman Miller, Steelcase, and Haworth strips available in a variety of heights.

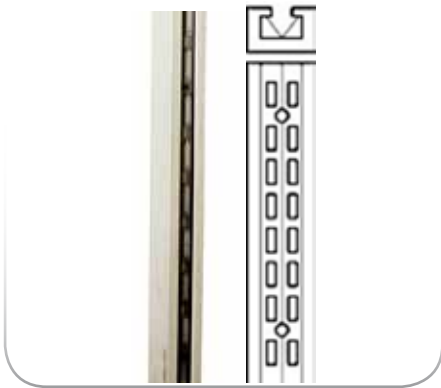

### HERMAN MILLER WALL MOUNTING STRIPS

SKU	Height	Price
M.0120.60.AL	60"	\$15.50
M.0120.72.AL	72"	\$18.00
M.0120.84.AL	84"	\$22.50

High quality slotted aluminum extrusion. Aluminum clear finish, with black insert. Attach directly to 5/8" drywall or solid wall surfaces. Works with Herman Miller A02 and SQA.

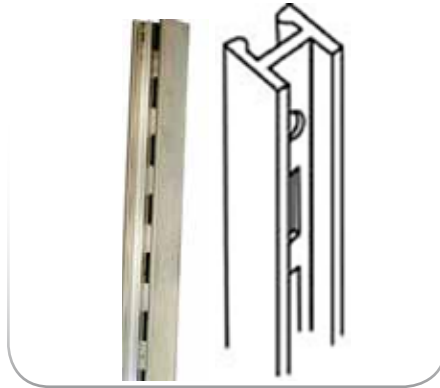

### STEELCASE WALL MOUNTING STRIPS

SKU	Height	Price
S.0008.65.UP	65"	\$19.25
S.0008.75.UP	75"	\$20.00

High quality slotted aluminum extrusion. Aluminum clear finish. Attach directly to 5/8" drywall or solid wall surfaces. Works with Steelcase 9000, Avenir, and Movable Wall.



### HAWORTH WALL MOUNTING STRIPS

SKU	Height	Price
H.0010.60.AL	60"	\$23.75
H.0010.72.AL	72"	\$28.00
H.0010.84.AL	84"	\$32.25

High quality slotted aluminum extrusion. Aluminum clear finish. Attach directly to 5/8" drywall or solid wall surfaces. Works with Haworth Unigroup and Places.

## WALL MOUNTING HARDWARE

Used to help attach wall mounting strips to drywall or solid wall surface. Toggler anchor and bolt can be used with Herman Miller, Steelcase, or Haworth strips.



### 3/16" TOGGLER BOLT ANCHOR

SKU	U.0085.01.00
Price	\$1.00

Use for wall mounting strips for hollow wall drywall application on 5/8" drywall.



### 3/16" X 3" TOGGLER BOLT

SKU	U.0086.01.ZI
Price	\$0.25

Use for wall mounting strips for hollow wall drywall application on 5/8" drywall.

# ADDITIONAL PRODUCTS

## OFFICE CHAIR REPLACEMENT PARTS

Replacement gas cylinder and chair base for office chairs. Please note that these parts are not to be used with Steelcase chairs



### 50MM GAS CYLINDER LIFT

SKU	U.0114.02.BK
Price	\$25.00



### UNIVERSAL CHAIR BASE 5 STAR, 50MM WITH CASTERS

SKU	U.0107.02.BK
Price	\$30.00

## HOT KNIFE

High-quality blade designed to cut fabric, cloth, webbing, ropes, and cords. The hot knife helps with fraying and seals the edges of the fabric. Heats up in seconds.



### HOT KNIFE WITH BLADE

SKU	U.0077.01.00
Price	\$321.00



### REPLACEMENT BLADE

SKU	U.0078.01.00
Price	\$60.00



## FABRIC STRETCH MACHINE

High-quality fabric stretch machine used to apply panel fabric. This machine grips all sides of the fabric, allowing to easily staple all sides down in a single move.

### ASSEMBLY FABRIC STRETCH MACHINE

SKU	U.0079.01.00
Price	\$8,500.00

# PAPER MANAGEMENT

## ALUMINUM TOOL BARS



### 36" ALUMINUM TOOL BAR

<b>SKU</b>	U.0155.36.BK
<b>Dimensions</b>	36" Nominal
<b>Price</b>	\$50.00

Attaches to most 1" tooth spread wall strips. One pair of mounting brackets (sold separately) needed to attach tool bar to panel unit. Used to mount paper trays, folder holders, or binder holders.

### 42" ALUMINUM TOOL BAR

<b>SKU</b>	U.0155.42.BK
<b>Dimensions</b>	42" Nominal
<b>Price</b>	\$55.00

Attaches to most 1" tooth spread wall strips. One pair of mounting brackets (sold separately) needed to attach tool bar to panel unit. Used to mount paper trays, folder holders, or binder holders.

### 48" ALUMINUM TOOL BAR

<b>SKU</b>	U.0155.46.BK
<b>Dimensions</b>	48" Nominal
<b>Price</b>	\$60.00

Attaches to most 1" tooth spread wall strips. One pair of mounting brackets (sold separately) needed to attach tool bar to panel unit. Used to mount paper trays, folder holders, or binder holders.

### MOUNTING BRACKET

<b>SKU</b>	U.0160.01.BK
<b>Price</b>	\$15.00

Sold in pairs. Used to attach the aluminum tool bar to the panel unit.

## TOOL BAR ACCESSORIES



### BINDER HOLDER

<b>SKU</b>	U.0165.04.BU
<b>Price</b>	\$10.50

Used to hold binders, catalogs, books, and more. Attaches to our aluminum tool bars.

### FOLDER HOLDER

<b>SKU</b>	U.0165.03.BU
<b>Price</b>	\$16.00

Used to hold project folders, has two dividers for three sections. Attaches to our aluminum tool bars.

### PENCIL HOLDER

<b>SKU</b>	U.0165.05.BK
<b>Price</b>	\$6.50

Used to hold pencils, pens, scissors, and more. Attaches to our aluminum tool bars.

### PAPER TRAY

<b>SKU</b>	U.0165.01.BU
<b>Price</b>	\$14.00

Letter sized paper tray. Used to hold a stack of standard 8 1/2" x 11" paper. Attaches to our aluminum tool bars.

# STEELCASE LEAP SERIES

## STEELCASE LEAP V1



### STEELCASE LEAP V1 FEATURES

The Leap is remanufactured by an authorized Steelcase service provider. The remanufactured Steelcase Leap V1 chair has a back that changes shape to support the entire spine. This can reduce the chance of lower back sag and a hunched posture. As you lean back, the seat glides forward so you can recline without affecting your vision and reach, so you stay oriented to your work. With the open slits in both its back and seat, and the special foam it uses, the remanufactured Steelcase Leap chair offers excellent "breathability." It effectively controls a balance of heat and moisture so you stay comfortable. Newly upholstered back and seat pad cushions are offered in our standard onyx color; other colors available.

SKU	DEPTH	WIDTH	HEIGHT	PRICE
U.0092H.B.XXXX	21 ¾" - 24 ¾"	27"	38 ½" - 43 ½"	\$675.00

## STEELCASE LEAP V2



### STEELCASE LEAP V2 FEATURES

The Leap is remanufactured by an authorized Steelcase service provider. The Leap V2 chair has a back that changes shape to support the entire spine. This can reduce the chance of lower back sag and a hunched posture. As you lean back, the seat glides forward so you can recline without affecting your vision and reach, so you stay oriented to your work. With the open slits in both its back and seat, and the special foam it uses, the Leap chair offers excellent "breathability." It effectively controls a balance of heat and moisture so you stay comfortable. The Leap V2 chair has adjustable lumbar support, which helps comfortably fit the curve of your lower back for additional support. Newly upholstered back and seat pad cushions are offered in our standard onyx color; other colors available.



SKU	DEPTH	WIDTH	HEIGHT	PRICE
U.0093H.B.XXXX	21 ¾" - 24 ¾"	27"	38 ½" - 43 ½"	\$760.00

\* NOTE: FOR FABRIC COLOR OPTIONS, PLEASE VIEW REFERENCE PAGE 80

# STEELCASE CRITERION CHAIR



## STEELCASE CRITERION FEATURES

The Criterion is remanufactured by an authorized Steelcase service provider. The remanufactured Steelcase Criterion desk chair is a high quality office chair that incorporates all current ergonomic adjustments, with soft curves and pleasing contours that provide all-day comfort and support. A heavy duty steel swivel tilt mechanism and sturdy base make the remanufactured Steelcase Criterion desk chair ideal for nearly all office situations. Newly upholstered back and seat pad cushions are offered in our standard onyx color; other colors available. The Criterion chair features an adjustable back height. Fully adjustable arms. Seat slider and adjustment. Seat tilt and tilt-lock adjustments.

SKU	DEPTH	WIDTH	HEIGHT	PRICE
U.0091H.B.XXXX	22 ½"	27 ½"	37 ½" - 44 ½"	\$318.00

**\* NOTE: FOR FABRIC COLOR OPTIONS, PLEASE VIEW REFERENCE PAGE 80**

# CRITERION PARTS / ACCESSORIES

## GAS CYLINDER



### CRITERION GAS CYLINDER

Replacement gas cylinder fits all Steelcase Criterion chairs.

Maximum Extension: 15"

Minimum Extension: 10 ½"

Amount of Adjustment: 4 ½"

SKU	PRICE
CS.0005.01.00	\$52.00

## ARM PADS



### CRITERION ARM PADS

Heavy-duty urethane arm pad with steel inserts that will not separate or loosen. Urethane skin provides outstanding comfort and wear.

SKU	PRICE
CS.0020.01.BK	\$72.00 / pair

## ARM PAD UNDERLAYS



### CRITERION ARM PAD UNDERLAYS

Used to convert old style arm pad to newer style Criterion arm. Available for H-Arm or DW-Arm. Sold in pairs.

SKU	STYLE	PRICE
CS.0021.01.BK	DW	\$10.00 / pair
CS.0021.02.BK	H	\$10.00 / pair

## CASTERS



### CRITERION CASTERS

Replacement casters fit all Steelcase Criterion chairs. Available for carpet or hard floor applications. Offered in packages of 5.

SKU	FLOOR TYPE	PRICE
CS.0030.01.BK	Soft Floor	\$28.00 / pkg of 5
CS.0030.02.BK	Hard Floor	\$32.00 / pkg of 5

# HERMAN MILLER



# PANEL BLANK HARDWARE

## COMPLEX HANGER FRAME / PANEL SHELL

Herman Miller complex hanger frame is used to turn a panel shell and block into one convenient piece. Attaches to the sides of the panels and will be attached to a wall, connector, or end cap. Punched from 14 gauge rolled steel. For use with Herman Miller AO1 and AO2 panels.



SKU	HEIGHT	PRICE (UP)	PRICE (BU or MT)	PAINTED PRICE*	COLOR OPTIONS
M.0411.34.XX	34" Nominal	\$7.50	\$8.50	\$13.00	
M.0411.42.XX	42" Nominal	\$8.75	\$10.00	\$14.50	
M.0411.48.XX	48" Nominal	\$10.00	\$11.50	\$16.00	
M.0411.62.XX	62" Nominal	\$13.00	\$15.00	\$19.50	
M.0411.80.XX	80" Nominal	\$15.50	\$18.00	\$22.50	

## PANEL WEDGE BLOCK SCREW

Herman Miller panel wedge block screw used to attach complex hanger frame to panel blanks.



SKU	COLOR	PRICE
U.0010.02.ZI	Zinc	\$0.25

## 96" PLASTIC TOP CAP

Herman Miller plastic top cap. Extruded plastic. Center barbed for use on Herman Miller AO1 or AO2 panels. Top cap must be cut to fit required panel width. Sold in 96" sections.



SKU	PRICE	COLOR OPTIONS
M.0056.01.XX	\$9.25	

\*NOTE: BOX QUANTITY PRICE (40 pieces): \$8.25

\* NOTE: PAINTED COMPLEX HANGER FRAMES REQUIRE A MINIMUM OF 20 TO BE ORDERED - 2 WEEK LEAD TIME

\* IF LESS THAN 20 ORDERED, A \$60.00 UPCHARGE WILL BE ADDED TO YOUR ORDER

# RACEWAY BASES

## "E" SERIES RACEWAY METAL BASE



### "E" SERIES RACEWAY METAL BASE

Steel base assembly for use with OEM style, AO2, Encore, and SQA. High quality steel base with pressure fit mounts for standard wood core panels. Includes mounting channel, metal raceway assembly, and glides. Does not include raceway covers.

SKU	HEIGHT	WIDTH	PRICE
M.0276.12.BK	5" Nominal	12" Nominal	\$8.00
M.0276.18.BK	5" Nominal	18" Nominal	\$9.50
M.0276.24.BK	5" Nominal	24" Nominal	\$10.50
M.0276.30.BK	5" Nominal	30" Nominal	\$11.75
M.0276.36.BK	5" Nominal	36" Nominal	\$12.50
M.0276.42.BK	5" Nominal	42" Nominal	\$14.00
M.0276.48.BK	5" Nominal	48" Nominal	\$14.75
M.0276.60.BK	5" Nominal	60" Nominal	\$16.75

## RACEWAY GLIDE



### RACEWAY GLIDE

Replacement glide to be used with "E" Series raceway metal base (sold individually).

SKU	PRICE
M.0057.02.DT	\$0.75 each

## NON-POWERED RACEWAY COVER



### NON-POWERED RACEWAY COVER

Non-powered raceway covers for use with OEM style, AO2, Encore, and SQA. High impact resistant plastic covers. Attaches to Herman Miller "E" Series metal bases. Two raceway covers are needed per base (sold individually).

SKU	HEIGHT	WIDTH	PRICE	COLOR OPTIONS
M.0209.12.XX	5" Nominal	12" Nominal	\$1.25	
M.0209.18.XX	5" Nominal	18" Nominal	\$1.75	
M.0209.24.XX	5" Nominal	24" Nominal	\$2.50	
M.0209.30.XX	5" Nominal	30" Nominal	\$3.00	
M.0209.36.XX	5" Nominal	36" Nominal	\$3.75	
M.0209.42.XX	5" Nominal	42" Nominal	\$4.50	
M.0209.48.XX	5" Nominal	48" Nominal	\$4.75	
M.0209.60.XX	5" Nominal	60" Nominal	\$6.25	

# POWERED RACEWAY COVERS

## "E" POWERED RACEWAY COVER (PENT)

### "E" POWERED RACEWAY COVER

Pent powered raceway covers for use with Unisource "E" and Mirage AO2 systems. High impact resistant plastic covers. Attaches to Herman Miller "E" Series metal bases. Two raceway covers are needed per base (sold individually).



SKU	HEIGHT	WIDTH	PRICE	COLOR OPTIONS
M.0236.24.XX	5" Nominal	24" Nominal	\$5.25	BU
M.0236.30.XX	5" Nominal	30" Nominal	\$5.75	
M.0236.36.XX	5" Nominal	36" Nominal	\$7.00	MT
M.0236.42.XX	5" Nominal	42" Nominal	\$7.25	
M.0236.48.XX	5" Nominal	48" Nominal	\$7.50	
M.0236.60.XX	5" Nominal	60" Nominal	\$8.50	

## "EI" POWERED RACEWAY COVER (V1)

### "EI" POWERED RACEWAY COVER

"EI" powered raceway covers for use with Unisource "EI" series. High impact resistant plastic covers. Attaches to Herman Miller "E" Series metal bases. Two raceway covers are needed per base (sold individually).



24" Cover Above



SKU	HEIGHT	WIDTH	PRICE	COLOR OPTIONS
M.0292.24.XX	5" Nominal	24" Nominal	\$5.25	BU
M.0292.30.XX	5" Nominal	30" Nominal	\$5.75	
M.0292.36.XX	5" Nominal	36" Nominal	\$7.00	MT
M.0292.42.XX	5" Nominal	42" Nominal	\$7.25	
M.0292.48.XX	5" Nominal	48" Nominal	\$7.50	
M.0292.60.XX	5" Nominal	60" Nominal	\$8.50	

## "OEM" POWERED RACEWAY COVER (V2)

### "OEM" POWERED RACEWAY COVER

"OEM" powered raceway covers for use with Herman Miller V2 power. High impact resistant plastic covers. Attaches to Herman Miller "E" Series metal bases. Two raceway covers are needed per base (sold individually).



SKU	HEIGHT	WIDTH	PRICE	COLOR OPTIONS
M.0004.24.XX	5" Nominal	24" Nominal	\$5.25	BU
M.0004.30.XX	5" Nominal	30" Nominal	\$5.75	
M.0004.36.XX	5" Nominal	36" Nominal	\$7.00	MT
M.0004.42.XX	5" Nominal	42" Nominal	\$7.25	
M.0004.48.XX	5" Nominal	48" Nominal	\$7.50	
M.0004.60.XX	5" Nominal	60" Nominal	\$8.50	

# RACEWAY KITS

## NON-POWERED WIRE MANAGEMENT KIT

### NON-POWERED WIRE MANAGEMENT KIT

Non-powered raceway base kit for use with OEM style, AO2, Encore, and SQA. Comes with two of the M.0209 raceway covers and one M.0276 metal base.



SKU	HEIGHT	WIDTH	PRICE	COLOR OPTIONS
M.0194.12.XX	5" Nominal	12" Nominal	\$10.75	 BU   MT
M.0194.18.XX	5" Nominal	18" Nominal	\$13.00	
M.0194.24.XX	5" Nominal	24" Nominal	\$15.50	
M.0194.30.XX	5" Nominal	30" Nominal	\$17.75	
M.0194.36.XX	5" Nominal	36" Nominal	\$20.00	
M.0194.42.XX	5" Nominal	42" Nominal	\$23.00	
M.0194.48.XX	5" Nominal	48" Nominal	\$24.25	
M.0194.60.XX	5" Nominal	60" Nominal	\$29.25	

## "OEM" POWERED WIRE MANAGEMENT KIT (V2)

### "OEM" POWERED WIRE MANAGEMENT KIT

"OEM" powered raceway kit for use with Herman Miller V2 power. High impact resistant plastic covers. Comes with two of the M.0004 raceway covers and one M.0276 metal base.



SKU	HEIGHT	WIDTH	PRICE	COLOR OPTIONS
M.0370.24.XX	5" Nominal	24" Nominal	\$21.00	 BU   MT
M.0370.30.XX	5" Nominal	30" Nominal	\$23.25	
M.0370.36.XX	5" Nominal	36" Nominal	\$26.50	
M.0370.42.XX	5" Nominal	42" Nominal	\$28.50	
M.0370.48.XX	5" Nominal	48" Nominal	\$29.75	
M.0370.60.XX	5" Nominal	60" Nominal	\$33.75	

## "EI" POWERED WIRE MANAGEMENT KIT (V1)

### "EI" POWERED WIRE MANAGEMENT KIT

Powered raceway base kit for use with Unisource "EI" series. Comes with two of the M.0292 raceway covers and one M.0276 metal base.



SKU	HEIGHT	WIDTH	PRICE	COLOR OPTIONS
M.0415.24.XX	5" Nominal	24" Nominal	\$21.00	 BU   MT
M.0415.30.XX	5" Nominal	30" Nominal	\$23.25	
M.0415.36.XX	5" Nominal	36" Nominal	\$26.50	
M.0415.42.XX	5" Nominal	42" Nominal	\$28.50	
M.0415.48.XX	5" Nominal	48" Nominal	\$29.75	
M.0415.60.XX	5" Nominal	60" Nominal	\$33.75	

# HERMAN MILLER POWER

## "EI" POWER ELECTRIC HARNESS (V1)

### "EI" POWER ELECTRIC HARNESS

Herman Miller's Version 1 power, A02 8-wire / 4-circuit, harness is used for converting a non-powered panel into a powered application. "EI" power is Underwriters Laboratories (UL) approved. Receptacles can be attached to each side of the harness (EI.0847 sold separately). This harness works with the M.0292 powered raceways (sold separately).



SKU	WIDTH	PRICE
EI.0843.24.00	24" Nominal	\$22.25
EI.0843.30.00	30" Nominal	\$24.00
EI.0843.36.00	36" Nominal	\$29.25
EI.0843.42.00	42" Nominal	\$37.00
EI.0843.48.00	48" Nominal	\$41.50
EI.0843.60.00	60" Nominal	\$54.25



### EI SERIES POWER RECEPTACLE 1/A

SKU EI.0847.C1.BK

Price \$8.50

Receptacle for use with EI series and V2 series powered systems. Shared neutral and ground circuit.

### EI SERIES POWER RECEPTACLE 2/B

SKU EI.0847.C2.BK

Price \$8.50

Receptacle for use with EI series and V2 series powered systems. Shared neutral and ground circuit.

### EI SERIES POWER RECEPTACLE 3/C

SKU EI.0847.C3.BK

Price \$8.50

Receptacle for use with EI series and V2 series powered systems. Shared neutral and ground circuit.

### EI SERIES POWER RECEPTACLE 4/D

SKU EI.0847.DC.OR

Price \$8.50

Receptacle for use with EI series and V2 series powered systems. Dedicated neutral and ground circuit.



Right-Hand



### EI SERIES POWER BASE FEED

SKU Price Hand

EI.0846.R6.BF \$99.00 Right

EI.0846.L6.BF \$99.00 Left

Used to bring power from the wall of a building to the panel unit. This item is UL recognized. When looking at the panel unit, the wires will run left/right of the receptacle.

### 18" EI SERIES POWER FESTOON

SKU EI.0208.18.00

Price \$20.50

This festoon, or jumper, is used to connect power to two harnesses from panel to panel. This item is UL recognized. This only works with EI Series power.

### 21" EI SERIES POWER FESTOON

SKU EI.0208.21.00

Price \$25.50

This festoon, or jumper, is used to connect power to two harnesses from panel through a connector. This item is UL recognized. This only works with EI Series power.

### SWIVELED POWER BASE FEED

SKU EI.0050.LR.BF

Price \$120.00



Used to bring power from the wall of a building to the panel unit. The connection is swiveled for both left or right feed directions. This base feed is 72" in length and works with EI series power.

# HERMAN MILLER POWER

## POWER POLES + ACCESSORIES





### 2" x 2" x 132" TELECOM POLE

SKU	M.0207.01.XX
Height	132"
Width	1.75"
Length	1.625"
Price	\$27.00
Color Options	 

Packaged in sections for UPS shipping. The sections can be reconnected together to construct the full 11' telecom pole. Used to run ceiling feeds or telephone lines from the ceiling to the work station.





### 2" x 2" POWER POLE TOP BEZEL

SKU	M.0309.01.XX
Outside Diameter	4"
Inside Measurement	2"
Price	\$7.25
Color Options	 

Metal, 2" x 2" bezel to be used with M.0207.01.XX.





### 3" x 4" x 144" TELECOM POLE

SKU	M.0207.02.XX
Height	144"
Width	3"
Length	4"
Price	\$58.00
Color Options	 

Used to run ceiling feeds or telephone lines from the ceiling to the work station.





### 3" x 4" POWER POLE TOP BEZEL

SKU	M.0207.03.XX
Width	3"
Length	4"
Price	\$2.50
Color Options	 

Plastic, 3" x 4" bezel to be used with M.0207.02.XX.



### POWER POLE RACEWAY TRIM

SKU	M.0207.04.XX
Price	\$2.75
Color Options	 

NOTE: This item fits M.0207.02.XX ONLY.



### 144" AO2 POWER CEILING FEED

SKU	M.0846.12.CF
Length	144"
Price	\$74.00

Used to bring power from the ceiling of a building, through a telecom pole, to the panel unit. A licensed electrician is responsible for connecting the feed to the power box in the ceiling. This ceiling feed is 144" in length, AO2 8-wire / 4-circuit, and works with EI series and Pent power.

# PANEL ACCESSORIES

## ASSEMBLED GLASS STACK ON MODULE

Herman Miller glass stacker for AO1 / AO2 systems. Steel, welded frame containing a glaze trim and tempered glass. Will require panel blank, hanger frame, and raceway components for installation (sold separately). Available in 14" and 18" heights.



SKU	HEIGHT	WIDTH	PRICE	COLOR OPTIONS
M.0326.1424.XX	14" Nominal	24" Nominal	\$53.00	
M.0326.1430.XX	14" Nominal	30" Nominal	\$62.00	
M.0326.1436.XX	14" Nominal	36" Nominal	\$71.00	
M.0326.1442.XX	14" Nominal	42" Nominal	\$79.00	
M.0326.1448.XX	14" Nominal	48" Nominal	\$88.00	
M.0326.1460.XX	14" Nominal	60" Nominal	\$104.00	



SKU	HEIGHT	WIDTH	PRICE	COLOR OPTIONS
M.0326.1824.XX	18" Nominal	24" Nominal	\$70.00	
M.0326.1830.XX	18" Nominal	30" Nominal	\$80.00	
M.0326.1836.XX	18" Nominal	36" Nominal	\$91.00	
M.0326.1842.XX	18" Nominal	42" Nominal	\$101.00	
M.0326.1848.XX	18" Nominal	48" Nominal	\$112.00	
M.0326.1860.XX	18" Nominal	60" Nominal	\$130.00	

## HERMAN MILLER PLASTIC COAT HOOK

Molded plastic coat hook for use over the panel top cap for Herman Miller AO style panels. Black Finish. Has foam block for locating and fitting in place. For use with 2" panel systems.



SKU	PRICE
M.0034.01.DT	\$1.50

## HERMAN MILLER DIVIDER CLAMP

Steel painted panel divider clamps. Used to hold 1/4" thick plexiglass dividers. Attaches to the top cap of Herman Miller AO1 and AO2 panels (use a 3/16" Allen Wrench to apply). A minimum of TWO clamps needed per plexiglass divider.



SKU	PRICE	COLOR OPTIONS
M.0700.01.XX	\$11.50	

# PLEXIGLASS

Made in the USA from acrylic, plexiglass is used to create a sound barrier and add extra privacy to any work surface. Use plexiglass as a modesty panel for free standing work surfaces. We currently offer plexiglass in three finishes: Clear, Frosted, and Bronze. Our plexiglass is available in three standard heights (14", 16", and 18") and multiple lengths ranging from 24" to 60". Custom sizes are available upon request, please contact customer service for more information.

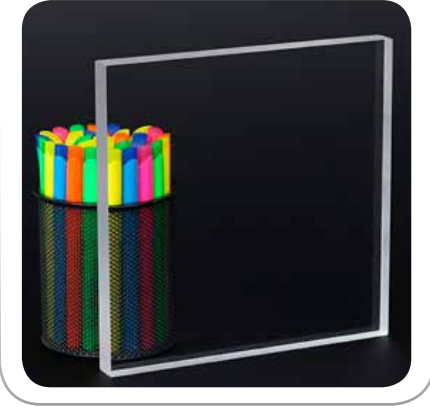

## CLEAR PLEXIGLASS

SKU	HEIGHT	LENGTH	PRICE
U.0701.1424.CL	14"	24"	\$37.50
U.0701.1430.CL	14"	30"	\$42.00
U.0701.1436.CL	14"	36"	\$50.00
U.0701.1442.CL	14"	42"	\$57.00
U.0701.1448.CL	14"	48"	\$94.50
U.0701.1460.CL	14"	60"	\$98.00
U.0701.1624.CL	16"	24"	\$43.50
U.0701.1630.CL	16"	30"	\$45.00
U.0701.1636.CL	16"	36"	\$63.00
U.0701.1642.CL	16"	42"	\$65.00
U.0701.1648.CL	16"	48"	\$131.00
U.0701.1660.CL	16"	60"	\$134.50
U.0701.1824.CL	18"	24"	\$44.00
U.0701.1830.CL	18"	30"	\$55.00
U.0701.1836.CL	18"	36"	\$63.50
U.0701.1842.CL	18"	42"	\$65.50
U.0701.1848.CL	18"	48"	\$131.50
U.0701.1860.CL	18"	60"	\$135.00

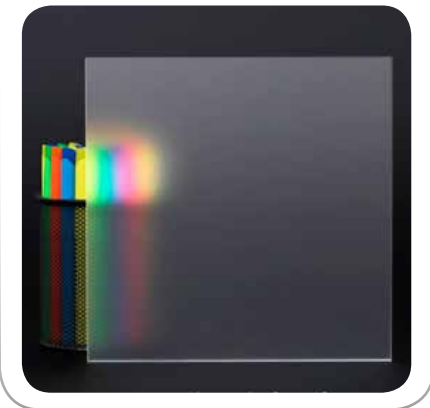

## FROSTED PLEXIGLASS

SKU	HEIGHT	LENGTH	PRICE
U.0702.1424.FR	14"	24"	\$48.50
U.0702.1430.FR	14"	30"	\$54.00
U.0702.1436.FR	14"	36"	\$66.00
U.0702.1442.FR	14"	42"	\$75.50
U.0702.1448.FR	14"	48"	\$131.00
U.0702.1460.FR	14"	60"	\$134.50
U.0702.1624.FR	16"	24"	\$57.00
U.0702.1630.FR	16"	30"	\$59.00
U.0702.1636.FR	16"	36"	\$85.00
U.0702.1642.FR	16"	42"	\$86.50
U.0702.1648.FR	16"	48"	\$185.50
U.0702.1660.FR	16"	60"	\$189.00
U.0702.1824.FR	18"	24"	\$57.50
U.0702.1830.FR	18"	30"	\$73.00
U.0702.1836.FR	18"	36"	\$85.50
U.0702.1842.FR	18"	42"	\$87.50
U.0702.1848.FR	18"	48"	\$186.50
U.0702.1860.FR	18"	60"	\$190.00

# PLEXIGLASS CONTINUED



BRONZE PLEXIGLASS			
SKU	HEIGHT	LENGTH	PRICE
U.0702.1424.BR	14"	24"	\$45.50
U.0702.1430.BR	14"	30"	\$50.50
U.0702.1436.BR	14"	36"	\$62.00
U.0702.1442.BR	14"	42"	\$70.50
U.0702.1448.BR	14"	48"	\$122.00
U.0702.1460.BR	14"	60"	\$125.50
U.0702.1624.BR	16"	24"	\$53.50
U.0702.1630.BR	16"	30"	\$55.50
U.0702.1636.BR	16"	36"	\$79.50
U.0702.1642.BR	16"	42"	\$81.00
U.0702.1648.BR	16"	48"	\$172.00
U.0702.1660.BR	16"	60"	\$175.50
U.0702.1824.BR	18"	24"	\$54.00
U.0702.1830.BR	18"	30"	\$68.50
U.0702.1836.BR	18"	36"	\$80.00
U.0702.1842.BR	18"	42"	\$81.50
U.0702.1848.BR	18"	48"	\$172.50
U.0702.1860.BR	18"	60"	\$176.00



Plexiglass paired with our universal divider clamps



Frosted plexiglass used as a modesty panel

# END CAPS

## ASSEMBLED END CAP - PLASTIC



### ASSEMBLED PLASTIC END CAP

Plastic end cap that will pressure fit to a panel hanger frame. Works with Herman Miller AO1 and AO2 systems. The M.0219.01 end cap trim cover is sold separately. Only available in Black Umber (BU) or Medium Tone (MT).

SKU	HEIGHT	PRICE	COLOR OPTIONS
M.0328.34.XX	34"	\$4.50	
M.0328.42.XX	42"	\$4.75	
M.0328.48.XX	48"	\$5.25	
M.0328.62.XX	62"	\$6.75	
M.0328.80.XX	80"	\$8.50	

## ASSEMBLED END CAP - METAL



### ASSEMBLED METAL END CAP

Aluminum end cap kit includes an end cap, top block, bottom block, and bolts to connect the blocks to the end cap. This end cap will attach to the end of a finished HM AO2 panel. The M.0219.01 end cap trim cover is sold separately.

SKU	HEIGHT	PRICE	COLOR OPTIONS
M.0171.34.XX	34"	\$13.75	
M.0171.42.XX	42"	\$15.00	
M.0171.48.XX	48"	\$17.00	
M.0171.62.XX	62"	\$20.50	
M.0171.80.XX	80"	\$25.25	

## METAL END CAP MIDDLE



### METAL END CAP MIDDLE

Steel middle end cap piece that is used with the M.0171 metal panel end cap kit. Top and bottom blocks are needed with this part to attach to the end of a panel. The M.0219.01 end cap trim cover is sold separately.

SKU	HEIGHT	UNPAINTED PRICE (UP)	PAINTED PRICE	COLOR OPTIONS
M.0068.34.XX	34"	\$6.25	\$8.25	
M.0068.42.XX	42"	\$7.50	\$9.00	
M.0068.48.XX	48"	\$8.75	\$11.25	
M.0068.62.XX	62"	\$12.00	\$14.00	
M.0068.80.XX	80"	\$15.50	\$19.00	

# END CAP + CONNECTOR HARDWARE

## END CAP PARTS



METAL END CAP TOP BLOCK	
SKU	M.0071.01.XX
Unpainted Price (UP)	\$2.00
Painted Price	\$2.25
Color Options	BU MT HT HF
	LG LT

Aluminum end cap top block piece that is used with the M.0171 panel end cap kit. This block is bolted to the end cap, which will attach to the top of the end of a panel.



METAL END CAP BOTTOM BLOCK	
SKU	M.0072.01.XX
Unpainted Price (UP)	\$2.00
Painted Price	\$2.25
Color Options	BU MT HT HF
	LG LT

Aluminum end cap bottom block piece that is used with the M.0171 panel end cap kit. This block is bolted to the end cap, which will attach to the bottom of the end of a panel.



END CAP BOLT		
SKU	Bolt	Price
U.0013.01.BK	Top	\$0.50
U.0013.02.BK	Bottom	\$0.50

The top bolt is used to bolt the end cap top block to the end cap middle. The bottom bolt is used to bolt the end cap bottom block to the end cap middle.



VARIABLE HEIGHT STRIP	
SKU	M.0132.04.XX
Dimensions	48" H x 2" W
Price (BU & MT)	\$6.50
Painted Price	\$12.25
Color Options	BU MT HT HF
	LG LT

A painted plastic piece used to finish the side of a connector post on a change of height panel. Can be cut down to fit different sized gaps.

## CONNECTOR ROD AND BLOCK



### CONNECTOR ROD AND BLOCK

Steel rod with connector blocks for panel to panel connections in a straight line. Measurements reflect actual for AO1 and nominal for AO2. These are ready to use assembled connectors. For use with Herman Miller AO1 and AO2 products. Black finish.

SKU	HEIGHT	AO1 / AO2	PRICE
M.0175.34.00	34"	34" / 39"	\$6.25
M.0175.42.00	42"	42" / 47"	\$7.00
M.0175.48.00	48"	48" / 53"	\$7.25
M.0175.62.00	62"	62" / 67"	\$9.00
M.0175.80.00	80"	80" / 85"	\$10.50

# CONNECTOR POSTS

## 2-WAY, 90 DEGREE CONNECTOR POST



### 2-WAY, 90 DEGREE CONNECTOR POST

90 degree, 2-way connector post used in the M.0459 connector kit. Use with Herman Miller AO1/AO2 systems.

SKU	HEIGHT	UNPAINTED PRICE (UP)	PAINTED PRICE	COLOR OPTIONS		
M.0059.34.XX	34"	\$20.00	\$22.00	BU	MT	HT
M.0059.42.XX	42"	\$25.00	\$28.00			
M.0059.48.XX	48"	\$28.00	\$31.00			
M.0059.62.XX	62"	\$35.00	\$38.00	HF	LG	LT
M.0059.80.XX	80"	\$47.00	\$50.00			

## 3-WAY, 90 DEGREE CONNECTOR POST



### 3-WAY, 90 DEGREE CONNECTOR POST

90 degree, 3-way connector post used in the M.0461 connector kit. Use with Herman Miller AO1/AO2 systems.

SKU	HEIGHT	UNPAINTED PRICE (UP)	PAINTED PRICE	COLOR OPTIONS		
M.0061.34.XX	34"	\$25.00	\$28.00	BU	MT	HT
M.0061.42.XX	42"	\$30.00	\$34.00			
M.0061.48.XX	48"	\$35.00	\$38.00			
M.0061.62.XX	62"	\$45.00	\$48.00	HF	LG	LT
M.0061.80.XX	80"	\$59.00	\$62.00			

## 4-WAY, 90 DEGREE CONNECTOR POST



### 4-WAY, 90 DEGREE CONNECTOR POST

90 degree, 4-way connector post used in the M.0462 connector kit. Use with Herman Miller AO1/AO2 systems.

SKU	HEIGHT	UNPAINTED PRICE (UP)	PAINTED PRICE	COLOR OPTIONS		
M.0062.34.XX	34"	\$26.00	\$29.00	BU	MT	HT
M.0062.42.XX	42"	\$32.00	\$35.00			
M.0062.48.XX	48"	\$36.00	\$39.00			
M.0062.62.XX	62"	\$46.00	\$49.00	HF	LG	LT
M.0062.80.XX	80"	\$60.00	\$63.00			

# CONNECTOR KITS

## 2-WAY, 90 DEGREE CONNECTOR KIT



### 2-WAY, 90 DEGREE CONNECTOR KIT

2-way, 90 degree connector used to connect two panels. Contains post, top cap, raceway trim, filler strip, top and bottom block, and hardware. Use with Herman Miller AO1/AO2 systems.

Note: Raceway Trim is available in Black Umber (B) or Medium Tone (M)

SKU	HEIGHT	PRICE	COLOR OPTIONS
M.0459.39X.XX	39"	\$39.00	
M.0459.47X.XX	47"	\$42.00	
M.0459.53X.XX	53"	\$47.00	
M.0459.67X.XX	67"	\$55.00	
M.0459.85X.XX	85"	\$65.00	

## 3-WAY, 90 DEGREE CONNECTOR KIT



### 3-WAY, 90 DEGREE ASSEMBLED CONNECTOR

3-way, 90 degree connector used to connect three panels. Contains post, top cap, raceway trim, filler strip, top and bottom block, and hardware. Use with Herman Miller AO1/AO2 systems.

Note: Raceway Trim is available in Black Umber (B) or Medium Tone (M)

SKU	HEIGHT	PRICE	COLOR OPTIONS
M.0461.39X.XX	39"	\$45.00	
M.0461.47X.XX	47"	\$52.00	
M.0461.53X.XX	53"	\$54.00	
M.0461.67X.XX	67"	\$61.00	
M.0461.85X.XX	85"	\$74.00	

## 4-WAY, 90 DEGREE CONNECTOR KIT



### 4-WAY, 90 DEGREE ASSEMBLED CONNECTOR

4-way, 90 degree connector used to connect four panels. Contains post, top cap, filler strip, top and bottom block, and hardware. Use with Herman Miller AO1/AO2 systems.

SKU	HEIGHT	PRICE	COLOR OPTIONS
M.0462.39X.XX	39"	\$45.00	
M.0462.47X.XX	47"	\$52.00	
M.0462.53X.XX	53"	\$55.00	
M.0462.67X.XX	67"	\$65.00	
M.0462.85X.XX	85"	\$80.00	

# CONNECTOR PARTS



## 2-WAY CONNECTOR TOP CAP

SKU M.0063.01.XX

Price \$0.50

Color Options 

BU	MT	HT	HF
LG	LT		

Painted plastic piece that connects to the top of an AO1 / AO2 90 degree 2-way connector post (M.0059).



## 3-WAY CONNECTOR TOP CAP

SKU M.0065.01.XX

Price \$0.75

Color Options 

BU	MT	HT	HF
LG	LT		

Painted plastic piece that connects to the top of an AO1 / AO2 90 degree 3-way connector post (M.0061).



## 4-WAY CONNECTOR TOP CAP

SKU M.0066.01.XX

Price \$0.75

Color Options 

BU	MT	HT	HF
LG	LT		

Painted plastic piece that connects to the top of an AO1 / AO2 90 degree 4-way connector post (M.0062).



## FILLER STRIP

SKU	Height	Price
M.0070.57.DT	57"	\$2.50
M.0070.01.DT	96"	\$4.00

Dark Tone plastic strip used fill the space between a Herman Miller connector post and a Herman Miller panel. One is needed for each side of the connector post. Can be cut down.



## CONNECTOR TOP BLOCK

SKU M.0413.01.BU

Price \$2.25

Black painted metal block, used to attach the top of a Herman Miller connector post to the top of a Herman Miller panel. One is needed for each side of the connector post.



## CONNECTOR BOTTOM BLOCK

SKU M.0216.01.BU

Price \$1.00

Black painted metal block, used to attach the bottom of a Herman Miller connector post to the bottom of a Herman Miller panel. One is needed for each side of the connector post.



## THREADED CONNECTOR PLATE

SKU M.0067.01.ZI

Price \$0.25

Threaded, zinc plated, connector used to attach the top and bottom blocks to a Herman Miller connector post.



## FLAT HEAD CONNECTOR BOLT

SKU U.0012.01.ZI

Price \$0.05

Zinc plated, Phillips head screw. Used to attach the threaded plate and top / bottom blocks to the connector post. Four of these screws will be needed for each side of the connector post.

# CONNECTOR PARTS + HARDWARE



## VARIABLE HEIGHT CLIP

SKU	M.0412.01.BU
Price	\$1.00

Used to connect a shorter panel to a taller panel with a connector rod. The height clip attaches to a connector rod and will clip onto a hanger frame of the shorter panel next to a taller panel.



## T-CONNECTOR TOP BLOCK

SKU	M.0164.01.BU
Price	\$2.00

Black painted metal block used to connect the top of the T-Connector shell to the top of the panel hanger frame. This is used in the M.0184 T-Connector kit.



## T-CONNECTOR BOTTOM BLOCK

SKU	M.0164.02.BU
Price	\$2.50

Black painted metal block used to connect the bottom of the T-Connector shell to the bottom of the panel hanger frame. This is used in the M.0184 T-Connector kit.



## 3/16" TOGGLER BOLT ANCHOR

SKU	U.0085.01.00
Price	\$1.00

Use for wall mounting strips for hollow wall drywall application on 5/8" drywall.



## 3/16" x 3" TOGGLER BOLT

SKU	U.0086.01.ZI
Price	\$0.25

Use for wall mounting strips for hollow wall drywall application on 5/8" drywall.

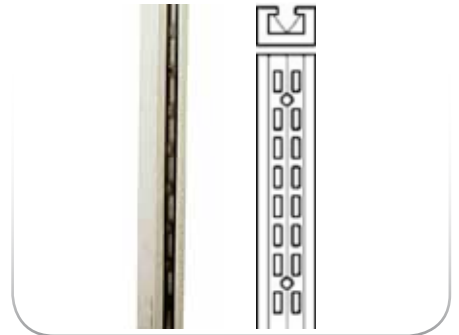

## WALL MOUNTING STRIPS

SKU	Height	Price
M.0120.60.AL	60"	\$15.50
M.0120.72.AL	72"	\$18.00
M.0120.84.AL	84"	\$22.50

High quality slotted aluminum extrusion. Aluminum clear finish, with black insert. Attach directly to 5/8" drywall or solid wall surfaces. Works with Herman Miller AO2 & SQA.

## WALL STARTS



### WALL START T-CONNECTOR KIT

Used for connecting a panel perpendicularly to a dry wall or similar application. Measurements reflect actual for AO1 and nominal AO2. Kit includes an upper and lower mounting block, wall start shell, and filler strip.

SKU	HEIGHT	AO1 / AO2	PRICE	COLOR OPTIONS
M.0184.34.XX	34"	34" / 39"	\$18.50	
M.0184.42.XX	42"	42" / 47"	\$22.50	
M.0184.48.XX	48"	48" / 53"	\$23.25	
M.0184.62.XX	62"	62" / 67"	\$26.25	
M.0184.80.XX	80"	80" / 85"	\$26.75	

# TRIM COVERS + ACCESSORIES

## AO2 CONNECTOR PARTS + RACEWAY COVERS

2-Way Connector Stem  
M.0224.2W.BK



3-Way Connector Stem  
M.0224.3W.BK



2-Way Cover Kit  
M.0219.02.XX



3-Way Cover Kit  
M.0219.03.XX



## AO2 TRIM COVERS

2-Way Trim Cover  
M.0232.2W.XX



3-Way Trim Cover  
M.0232.3W.XX



2-Way Trim Cover  
M.0408.2W.XX



3 Way Trim Cover  
M.0408.3W.XX



## TRIM + OUTLET COVERS

End Cap Trim Cover  
M.0219.01.XX



AO2 Outlet Cover  
M.0219.08.XX



AO2 Outlet Cover (Holes)  
M.0164.03.XX



Data Jack  
\*See Chart



# TRIM COVERS + ACCESSORIES

## AO2 CONNECTOR PARTS + RACEWAY COVERS

### 90 DEGREE 2-WAY OR 3-WAY CONNECTOR STEM

Black plastic piece, used as a foot for supporting a Herman Miller AO2 90 degree 2-way or 3-way connector.

### 90 DEGREE 2-WAY OR 3-WAY TRIM COVER KIT

A kit that is used for the bottom of a Herman Miller AO2 90 degree 2-way or 3-way connector. Includes one cover, one stem, and two threaded plates.

PRODUCT DESCRIPTION	SKU	DIMENSIONS	PRICE	COLOR OPTIONS
AO2 90 Degree 2-Way Connector Stem	M.0224.2W.BK	5" H Nominal	\$2.50	Only available in Black
AO2 90 Degree 3-Way Connector Stem	M.0224.3W.BK	5" H Nominal	\$2.50	Only available in Black
AO2 90 Degree 2-Way Trim Cover Kit	M.0219.02.XX	5" H Nominal	\$5.00	
AO2 90 Degree 3-Way Trim Cover Kit	M.0219.03.XX	5" H Nominal	\$4.75	

## AO2 TRIM COVERS

### AO2 90 DEGREE 2-WAY OR 3-WAY TRIM COVER

Painted plastic piece, used as a cover for the bottom of a Herman Miller AO2 90 degree 2-way or 3-way connector.

NOTE: Order threaded plate and stem separately

### AO2 120 DEGREE 2-WAY OR 3-WAY TRIM COVER

Painted plastic piece, used as a cover for the bottom of a Herman Miller AO2 120 degree 2-way or 3-way connector.

PRODUCT DESCRIPTION	SKU	DIMENSIONS	PRICE	COLOR OPTIONS
AO2 90 Degree 2-Way Trim Cover	M.0232.2W.XX	5" H Nominal	\$2.00	
AO2 90 Degree 3-Way Trim Cover	M.0232.3W.XX	5" H Nominal	\$1.50	
AO2 120 Degree 2-Way Trim Cover	M.0408.2W.XX	5" H Nominal	\$1.50	
AO2 120 Degree 3-way Trim Cover	M.0408.3W.XX	5" H Nominal	\$1.00	

## TRIM + OUTLET COVERS

### END CAP TRIM COVER

Plastic trim piece used at the end of panel at the base.

### OUTLET COVER

Plastic trim piece used to cover outlets on raceway. The outlet cover with holes fits standard Keystone Style AMP or Leviton Type Jacks (Jacks are not included).

PRODUCT DESCRIPTION	SKU	PRICE	COLOR OPTIONS
A02 End Cap Trim Cover	M.0219.01.XX	\$1.75	
Outlet Cover (Blank)	M.0219.08.XX	\$0.50	
Outlet Cover w/ 2 Holes for AMP / Leviton	U.0164.03.XX	\$0.75	
Data Jack - RJ45 CAT 5e	U.0192.03.BK	\$10.00	Black
Data Jack - RJ45, CAT 6	U.0192.04.OR	\$10.00	Orange
Telecommunications Jack - RJ11	U.0192.01.BK	\$6.50	Black

# HERMAN MILLER SHELVING UNITS

## AO2 LOW SHELF ENDS

7 ½" high, 12 ½" deep, and ½" wide, durable wood core shelf ends with steel mounting bracket attached. For use with standard 13" deep Herman Miller AO1 and AO2 shelf pans and flipper doors.



SKU	HEIGHT	WIDTH	PRICE	COLOR OPTIONS					
M.0196.03.XX	7 ½" Nominal	12 ½" Nominal	\$40.00 / pair	BU	MT	HT	HF	LG	LT

## AO2 HIGH SHELF ENDS

15 ½" high, 12 ½" deep, and ½" wide, durable wood core shelf ends with steel mounting bracket attached. For use with standard 13" deep Herman Miller AO1 and AO2 shelf pans and flipper doors.



SKU	HEIGHT	WIDTH	PRICE	COLOR OPTIONS					
M.0196.01.XX	15 ½" Nominal	12 ½" Nominal	\$40.00 / pair	BU	MT	HT	HF	LG	LT

## AO2 SHELF PAN

12" deep, ¾" high, steel shelf pan, used with Herman Miller AO1 and AO2 series. Steel formed lip with lock position for flipper door application. Does not include shelf ends, hardware, or screws.



SKU	WIDTH	UNPAINTED PRICE	PAINTED PRICE	COLOR OPTIONS	
M.0092.24.XX	24" Nominal	\$15.50	\$15.50	BU	MT
M.0092.30.XX	30" Nominal	\$18.00	\$18.00		
M.0092.36.XX	36" Nominal	\$22.00	\$22.00	HT	HF
M.0092.42.XX	42" Nominal	\$24.00	\$24.00		
M.0092.48.XX	48" Nominal	\$26.50	\$26.50	LG	LT
M.0092.60.XX	60" Nominal	\$33.50	\$33.50		

## AO2 UNASSEMBLED SHELF KIT

For use with the Herman Miller AO1 and AO2 series. Kit includes one M.0092.XX.XX metal shelf pan and one pair of M.0196.01.XX wooden high shelf ends.



SKU	HEIGHT	WIDTH	PRICE	COLOR OPTIONS	
M.0200.24.XX	15 ½" Nominal	24" Nominal	\$55.50	BU	MT
M.0200.30.XX	15 ½" Nominal	30" Nominal	\$58.00		
M.0200.36.XX	15 ½" Nominal	36" Nominal	\$62.00	HT	HF
M.0200.42.XX	15 ½" Nominal	42" Nominal	\$64.00		
M.0200.48.XX	15 ½" Nominal	48" Nominal	\$66.50	LG	LT
M.0200.60.XX	15 ½" Nominal	60" Nominal	\$73.50		

# HERMAN MILLER PARTS

## FLIPPER DOOR PARTS + SHELF HARDWARE



### AO1 LOCK KIT

SKU	M.0124.02.00
Price	\$6.50

Herman Miller AO1 lock kit for storage units.



### AO2 LOCK KIT W/ HOOK

SKU	M.0174.01.00
Price	\$4.00

Herman Miller AO2 lock kit for storage units.



### LATERAL FILE CLIP

SKU	M.0181.01.DT
Price	\$2.25 / pair

Used with the Herman Miller complex hanger frame (M.0411) to attach tack / marker board to panel.

## 12" HM AO2 "E" SERIES TACK BOARD BLANK\*

Herman Miller AO2 "E" Series tack board blanks.

NOTE: All tack boards are blanks only. Mounting hardware sold separately.

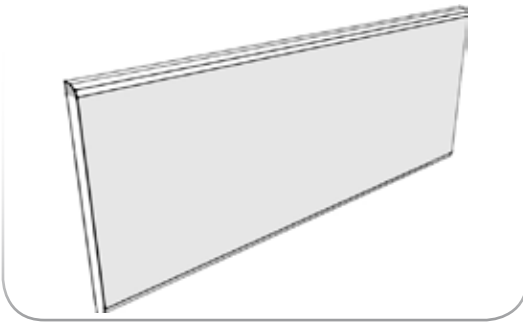

SKU	HEIGHT	WIDTH	PRICE
M.0139.12.24	12" Nominal	24" Nominal	\$12.00
M.0139.12.30	12" Nominal	30" Nominal	\$17.00
M.0139.12.36	12" Nominal	36" Nominal	\$18.00
M.0139.12.42	12" Nominal	42" Nominal	\$19.00
M.0139.12.48	12" Nominal	48" Nominal	\$21.00
M.0139.12.60	12" Nominal	60" Nominal	\$24.00

## 16" HM AO2 "E" SERIES TACK BOARD BLANK\*

Herman Miller AO2 "E" Series tack board blanks.

NOTE: All tack boards are blanks only. Mounting hardware sold separately.

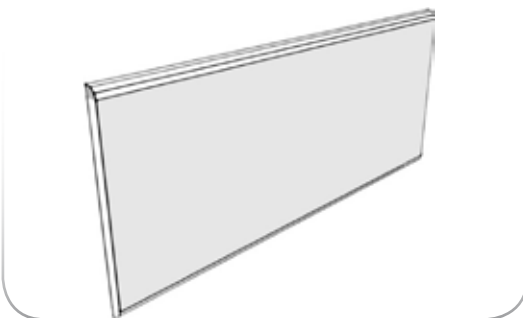

SKU	HEIGHT	WIDTH	PRICE
M.0139.16.24	16" Nominal	24" Nominal	\$13.50
M.0139.16.30	16" Nominal	30" Nominal	\$16.50
M.0139.16.36	16" Nominal	36" Nominal	\$20.00
M.0139.16.42	16" Nominal	42" Nominal	\$21.00
M.0139.16.48	16" Nominal	48" Nominal	\$23.00
M.0139.16.60	16" Nominal	60" Nominal	\$26.00

\* NOTE: MINIMUM ORDER QUANTITY - 10 TACK BOARD BLANKS  
 \* IF LESS THAN 10 ORDERED, A \$25.00 UPCHARGE WILL BE ADDED TO YOUR ORDER

# PANEL BLANKS

## HARD SURFACE PANEL BLANKS, NO HARDWARE



Herman Miller raw panel blanks that are ready for fabric application and assembly. Our panel blanks feature a hollow core with mounting slots. For use with AO1 and AO2 systems. Available in a variety of heights and widths. Measurements reflect actual for AO1 and nominal for AO2.

SKU	HEIGHT	WIDTH	PRICE
<b>AO1 / AO2 - 34" / 39"</b>			
M.0050.34.12	34" Nominal	12" Nominal	\$29.00
M.0050.34.18	34" Nominal	18" Nominal	\$32.00
M.0050.34.24	34" Nominal	24" Nominal	\$36.00
M.0050.34.30	34" Nominal	30" Nominal	\$38.00
M.0050.34.36	34" Nominal	36" Nominal	\$44.00
M.0050.34.42	34" Nominal	42" Nominal	\$46.00
M.0050.34.48	34" Nominal	48" Nominal	\$52.00
M.0050.34.60	34" Nominal	60" Nominal	\$58.00
<b>AO1 / AO2 - 42" / 47"</b>			
M.0050.42.12	42" Nominal	12" Nominal	\$30.00
M.0050.42.18	42" Nominal	18" Nominal	\$33.00
M.0050.42.24	42" Nominal	24" Nominal	\$38.00
M.0050.42.30	42" Nominal	30" Nominal	\$42.00
M.0050.42.36	42" Nominal	36" Nominal	\$48.00
M.0050.42.42	42" Nominal	42" Nominal	\$57.00
M.0050.42.48	42" Nominal	48" Nominal	\$61.00
M.0050.42.60	42" Nominal	60" Nominal	\$67.00
<b>AO1 / AO2 - 48" / 53"</b>			
M.0050.48.12	48" Nominal	12" Nominal	\$30.00
M.0050.48.18	48" Nominal	18" Nominal	\$35.00
M.0050.48.24	48" Nominal	24" Nominal	\$38.00
M.0050.48.30	48" Nominal	30" Nominal	\$42.00
M.0050.48.36	48" Nominal	36" Nominal	\$48.00
M.0050.48.42	48" Nominal	42" Nominal	\$57.00
M.0050.48.48	48" Nominal	48" Nominal	\$60.00
M.0050.48.60	48" Nominal	60" Nominal	\$67.00
<b>AO1 / AO2 - 57" / 62"</b>			
M.0050.57.12	57" Nominal	12" Nominal	\$32.00
M.0050.57.18	57" Nominal	18" Nominal	\$38.00
M.0050.57.24	57" Nominal	24" Nominal	\$39.00
M.0050.57.30	57" Nominal	30" Nominal	\$43.00
M.0050.57.36	57" Nominal	36" Nominal	\$49.00
M.0050.57.42	57" Nominal	42" Nominal	\$55.00
M.0050.57.48	57" Nominal	48" Nominal	\$63.00
M.0050.57.60	57" Nominal	60" Nominal	\$74.00



# PANEL BLANKS CONTINUED

## HARD SURFACE PANEL BLANKS, NO HARDWARE

SKU	HEIGHT	WIDTH	PRICE
<b>A01 / A02 - 62" / 67"</b>			
M.0050.62.12	62" Nominal	12" Nominal	\$43.00
M.0050.62.18	62" Nominal	18" Nominal	\$44.00
M.0050.62.24	62" Nominal	24" Nominal	\$45.00
M.0050.62.30	62" Nominal	30" Nominal	\$49.00
M.0050.62.36	62" Nominal	36" Nominal	\$55.00
M.0050.62.42	62" Nominal	42" Nominal	\$61.00
M.0050.62.48	62" Nominal	48" Nominal	\$68.00
M.0050.62.60	62" Nominal	60" Nominal	\$78.00
<b>A01 / A02 - 80" / 85"</b>			
M.0050.80.12	80" Nominal	12" Nominal	\$44.00
M.0050.80.18	80" Nominal	18" Nominal	\$51.00
M.0050.80.24	80" Nominal	24" Nominal	\$52.00
M.0050.80.30	80" Nominal	30" Nominal	\$57.00
M.0050.80.36	80" Nominal	36" Nominal	\$69.00
M.0050.80.42	80" Nominal	42" Nominal	\$76.00
M.0050.80.48	80" Nominal	48" Nominal	\$83.00
M.0050.80.60	80" Nominal	60" Nominal	\$95.00



# PANEL BLANKS CONTINUED

## TACKABLE PANEL BLANKS

Herman Miller tackable panel blanks. For use with AO1 and AO2 systems. Available in a variety of heights and widths. Measurements reflect actual for AO1 and nominal for AO2.

SKU	HEIGHT	WIDTH	PRICE
<b>AO1 / AO2 - 48" / 53"</b>			
M.0049.48.12	48" Nominal	12" Nominal	\$44.00
M.0049.48.18	48" Nominal	18" Nominal	\$52.00
M.0049.48.24	48" Nominal	24" Nominal	\$59.00
M.0049.48.30	48" Nominal	30" Nominal	\$66.00
M.0049.48.36	48" Nominal	36" Nominal	\$70.00
M.0049.48.42	48" Nominal	42" Nominal	\$77.00
M.0049.48.48	48" Nominal	48" Nominal	\$85.00
M.0049.48.60	48" Nominal	60" Nominal	\$95.00
<b>AO1 / AO2 - 57" / 52"</b>			
M.0049.57.12	57" Nominal	12" Nominal	\$46.00
M.0049.57.18	57" Nominal	18" Nominal	\$50.00
M.0049.57.24	57" Nominal	24" Nominal	\$60.00
M.0049.57.30	57" Nominal	30" Nominal	\$69.00
M.0049.57.36	57" Nominal	36" Nominal	\$76.00
M.0049.57.42	57" Nominal	42" Nominal	\$84.00
M.0049.57.48	57" Nominal	48" Nominal	\$92.00
M.0049.57.60	57" Nominal	60" Nominal	\$108.00
<b>AO1 / AO2 - 62" / 67"</b>			
M.0049.62.12	62" Nominal	12" Nominal	\$49.00
M.0049.62.18	62" Nominal	18" Nominal	\$56.00
M.0049.62.24	62" Nominal	24" Nominal	\$63.00
M.0049.62.30	62" Nominal	30" Nominal	\$72.00
M.0049.62.36	62" Nominal	36" Nominal	\$79.00
M.0049.62.42	62" Nominal	42" Nominal	\$92.00
M.0049.62.48	62" Nominal	48" Nominal	\$100.00
M.0049.62.60	62" Nominal	60" Nominal	\$110.00
<b>AO1 / AO2 - 80" / 85"</b>			
M.0049.80.12	80" Nominal	12" Nominal	\$62.00
M.0049.80.18	80" Nominal	18" Nominal	\$68.00
M.0049.80.24	80" Nominal	24" Nominal	\$76.00
M.0049.80.30	80" Nominal	30" Nominal	\$87.00
M.0049.80.36	80" Nominal	36" Nominal	\$98.00
M.0049.80.42	80" Nominal	42" Nominal	\$110.00
M.0049.80.48	80" Nominal	48" Nominal	\$118.00
M.0049.80.60	80" Nominal	60" Nominal	\$136.00

# STACK ON MODULES

## HARD SURFACE STACK ON MODULE, NO HARDWARE

Herman Miller stack on modules for AO1 / AO2 systems. Use on top of panels for added height to help block out noise.

### 6" STACK ON MODULE



SKU	HEIGHT	WIDTH	PRICE
M.0410.06.24	6" Nominal	24" Nominal	\$20.00
M.0410.06.30	6" Nominal	30" Nominal	\$22.00
M.0410.06.36	6" Nominal	36" Nominal	\$24.00
M.0410.06.42	6" Nominal	42" Nominal	\$27.00
M.0410.06.48	6" Nominal	48" Nominal	\$28.00
M.0410.06.60	6" Nominal	60" Nominal	\$32.00

### 8" STACK ON MODULE



SKU	HEIGHT	WIDTH	PRICE
M.0410.08.24	8" Nominal	24" Nominal	\$21.00
M.0410.08.30	8" Nominal	30" Nominal	\$23.00
M.0410.08.36	8" Nominal	36" Nominal	\$25.00
M.0410.08.42	8" Nominal	42" Nominal	\$28.00
M.0410.08.48	8" Nominal	48" Nominal	\$30.00
M.0410.08.60	8" Nominal	60" Nominal	\$34.00

### 14" STACK ON MODULE



SKU	HEIGHT	WIDTH	PRICE
M.0410.14.24	14" Nominal	24" Nominal	\$24.00
M.0410.14.30	14" Nominal	30" Nominal	\$28.00
M.0410.14.36	14" Nominal	36" Nominal	\$30.00
M.0410.14.42	14" Nominal	42" Nominal	\$33.00
M.0410.14.48	14" Nominal	48" Nominal	\$34.00
M.0410.14.60	14" Nominal	60" Nominal	\$42.00

### 18" STACK ON MODULE



SKU	HEIGHT	WIDTH	PRICE
M.0410.18.24	18" Nominal	24" Nominal	\$27.00
M.0410.18.30	18" Nominal	30" Nominal	\$30.00
M.0410.18.36	18" Nominal	36" Nominal	\$33.00
M.0410.18.42	18" Nominal	42" Nominal	\$36.00
M.0410.18.48	18" Nominal	48" Nominal	\$38.00
M.0410.18.60	18" Nominal	60" Nominal	\$44.00

\* NOTE: MINIMUM ORDER QUANTITY OF 10, MAY BE MIXED SIZES  
 \* IF LESS THAN 10 ORDERED, A \$25.00 UPCHARGE WILL BE ADDED TO YOUR ORDER

# HM WORK SURFACE HARDWARE



## 24" A02 SUPPORT ARMS

SKU	M.0274.24.XX										
Depth	24" Nominal										
Price (BU + MT)	\$13.75 / pair										
Painted Price*	\$23.00 / pair										
Color Options	<table border="1"> <tr> <td>BU</td> <td>MT</td> <td>HT</td> <td>HF</td> <td>LG</td> </tr> <tr> <td>LT</td> <td></td> <td></td> <td></td> <td></td> </tr> </table>	BU	MT	HT	HF	LG	LT				
BU	MT	HT	HF	LG							
LT											

16 1/4" high-quality steel stamped cantilevers. Includes mounting hardware and leveling screws. Works with 24" deep Herman Miller AO1 and AO2 style work surfaces. Offered per pair, left-hand and right-hand.



## 30" A02 SUPPORT ARMS

SKU	M.0274.30.XX										
Depth	30" Nominal										
Price (BU + MT)	\$22.00 / pair										
Painted Price*	\$31.25 / pair										
Color Options	<table border="1"> <tr> <td>BU</td> <td>MT</td> <td>HT</td> <td>HF</td> <td>LG</td> </tr> <tr> <td>LT</td> <td></td> <td></td> <td></td> <td></td> </tr> </table>	BU	MT	HT	HF	LG	LT				
BU	MT	HT	HF	LG							
LT											

22 1/4" high-quality steel stamped cantilevers. Includes mounting hardware and leveling screws. Works with 30" deep Herman Miller AO1 and AO2 style work surfaces. Offered per pair, left-hand and right-hand.



## A02 CORNER WORK SURFACE BRACKET

SKU	M.0144.01.BK
Price	\$1.75 / pair

For use with Herman Miller AO1 and AO2 systems. Black finish. Offered in pairs, left-hand and right-hand pieces together.



## 3 1/2" COUNTER CAP SUP BRACKET

SKU	M.0233.01.BK
Price	\$3.25

For use with Herman Miller AO1 and AO2 systems. Black finish. Attaches to hanger frame on panel to hold a counter cap work surface.



## A02 SUPPORT ARM PINS AND BUTTONS

SKU	M.0290.01.00
Price	\$0.75

Work surface retainer pins, buttons, and leveling Allen bolts. Pair of leveling bolts, buttons for rear of work surface support arms, and pins for front of work surface support arms. Also works as replacement for missing OEM style pins and buttons.



## A02 T-MOLD

SKU	Width	FT/Roll	Price	Color Options										
M.0081.01.XX	1 1/8"	250	\$126.50	<table border="1"> <tr> <td>BU</td> <td>MT</td> <td>DT</td> <td>HT</td> <td>HF</td> </tr> <tr> <td>LG</td> <td>LT</td> <td></td> <td></td> <td></td> </tr> </table>	BU	MT	DT	HT	HF	LG	LT			
BU	MT	DT	HT	HF										
LG	LT													
M.0081.02.XX	1 1/2"	200	\$213.25											

Used for edging on a work surface. Available in roll only.

**\* PAINTED SUPPORT ARMS WILL REQUIRE A MINIMUM OF 20 TO BE ORDERED - 2 WEEK LEAD TIME**  
**\* IF LESS THAN 20 ORDERED, A \$60.00 UPCHARGE WILL BE ADDED TO YOUR ORDER**

# MELAMINE WORK SURFACES

## 24" DEEP, MELAMINE, RECTANGULAR WORK SURFACE

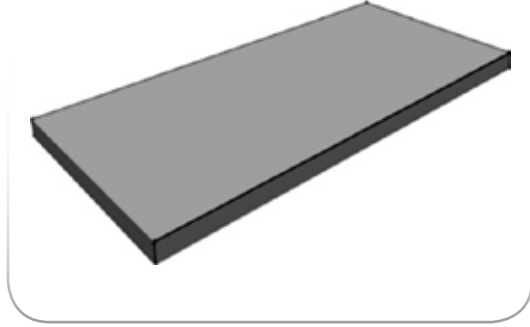

SKU	DEPTH	WIDTH	PRICE
M.0323.24.24	24" Nominal	24" Nominal	\$41.75
M.0323.30.24	24" Nominal	30" Nominal	\$52.25
M.0323.36.24	24" Nominal	36" Nominal	\$62.75
M.0323.42.24	24" Nominal	42" Nominal	\$73.25
M.0323.48.24	24" Nominal	48" Nominal	\$83.75
M.0323.54.24	24" Nominal	54" Nominal	\$104.75
M.0323.60.24	24" Nominal	60" Nominal	\$104.75
M.0323.66.24	24" Nominal	66" Nominal	\$125.50
M.0323.72.24	24" Nominal	72" Nominal	\$125.50
M.0323.84.24	24" Nominal	84" Nominal	\$146.50
M.0323.96.24	24" Nominal	96" Nominal	\$146.50

## 30" DEEP, MELAMINE, RECTANGULAR WORK SURFACE

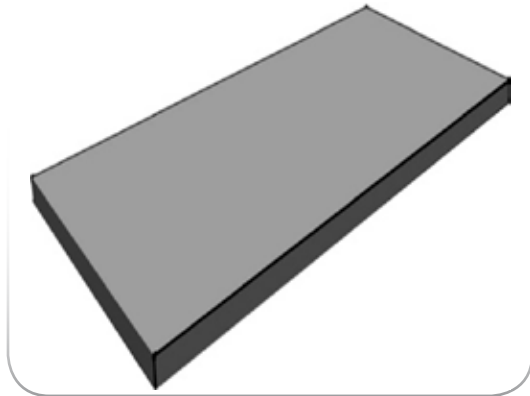

SKU	DEPTH	WIDTH	PRICE
M.0323.30.30	30" Nominal	30" Nominal	\$65.25
M.0323.36.30	30" Nominal	36" Nominal	\$78.50
M.0323.42.30	30" Nominal	42" Nominal	\$91.50
M.0323.48.30	30" Nominal	48" Nominal	\$104.50
M.0323.54.30	30" Nominal	54" Nominal	\$131.00
M.0323.60.30	30" Nominal	60" Nominal	\$131.00
M.0323.66.30	30" Nominal	66" Nominal	\$157.00
M.0323.72.30	30" Nominal	72" Nominal	\$157.00
M.0323.84.30	30" Nominal	84" Nominal	\$183.00
M.0323.96.30	30" Nominal	96" Nominal	\$209.50

## MELAMINE, ROUND OR SQUARE TABLE TOP

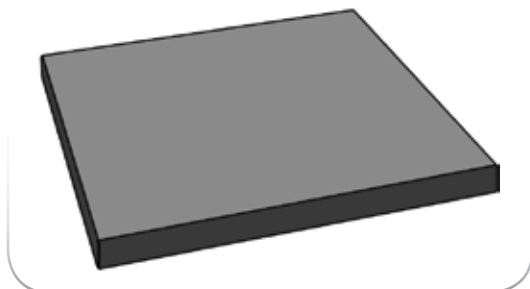

SKU	DEPTH	PRICE
<b>ROUND TABLE TOP</b>		
M.0480.30.00	30" Diameter	\$65.25
M.0480.36.00	36" Diameter	\$92.50
M.0480.42.00	42" Diameter	\$163.00
M.0480.48.00	48" Diameter	\$163.00
M.0480.60.00	60" Diameter	\$255.00
<b>SQUARE TABLE TOP</b>		
M.0491.30.00	30" Diameter	\$65.25
M.0491.36.00	36" Diameter	\$92.50
M.0491.42.00	42" Diameter	\$163.00
M.0491.48.00	48" Diameter	\$163.00
M.0491.60.00	60" Diameter	\$255.00

\* NOTE: MINIMUM ORDER QUANTITY - 5 WORK SURFACE TOPS, ADDITIONAL FEES APPLIED IF LESS THAN 5 ORDERED  
 \* FOR MELAMINE TOP + TRIM COLOR CHOICES, PLEASE VIEW REFERENCE PAGE 81

# HIGH PRESSURE WORK SURFACES

## 24" DEEP, HIGH PRESSURE, RECTANGULAR WORK SURFACE

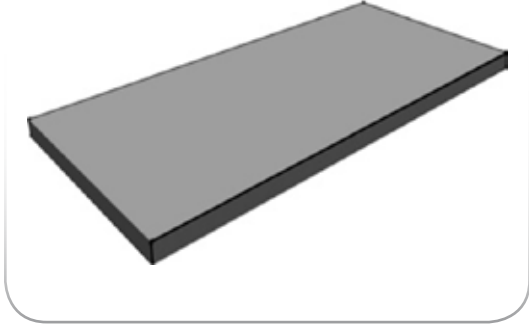

SKU	DEPTH	WIDTH	PRICE
M.0179.24.24	24" Nominal	24" Nominal	\$53.75
M.0179.30.24	24" Nominal	30" Nominal	\$67.25
M.0179.36.24	24" Nominal	36" Nominal	\$80.75
M.0179.42.24	24" Nominal	42" Nominal	\$94.00
M.0179.48.24	24" Nominal	48" Nominal	\$107.50
M.0179.54.24	24" Nominal	54" Nominal	\$134.50
M.0179.60.24	24" Nominal	60" Nominal	\$134.50
M.0179.66.24	24" Nominal	66" Nominal	\$161.50
M.0179.72.24	24" Nominal	72" Nominal	\$161.50
M.0179.84.24	24" Nominal	84" Nominal	\$188.25
M.0179.96.24	24" Nominal	96" Nominal	\$215.00

## 30" DEEP, HIGH PRESSURE, RECTANGULAR WORK SURFACE

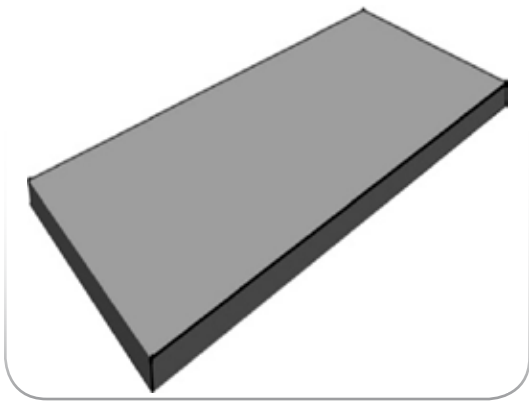

SKU	DEPTH	WIDTH	PRICE
M.0179.24.30	30" Nominal	24" Nominal	\$67.25
M.0179.30.30	30" Nominal	30" Nominal	\$88.75
M.0179.36.30	30" Nominal	36" Nominal	\$101.00
M.0179.42.30	30" Nominal	42" Nominal	\$117.50
M.0179.48.30	30" Nominal	48" Nominal	\$134.50
M.0179.54.30	30" Nominal	54" Nominal	\$168.25
M.0179.60.30	30" Nominal	60" Nominal	\$168.25
M.0179.66.30	30" Nominal	66" Nominal	\$201.75
M.0179.72.30	30" Nominal	72" Nominal	\$201.75
M.0179.84.30	30" Nominal	84" Nominal	\$235.25
M.0179.96.30	30" Nominal	96" Nominal	\$274.50

## HIGH PRESSURE, ROUND OR SQUARE TABLE TOP

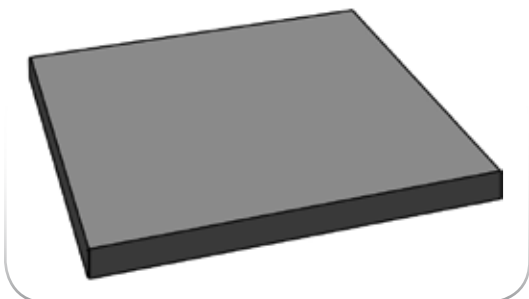

SKU	DEPTH	PRICE
<b>ROUND TABLE TOP</b>		
M.0280.24.00	24" Diameter	\$80.75
M.0280.30.00	30" Diameter	\$88.75
M.0280.36.00	36" Diameter	\$129.25
M.0280.42.00	42" Diameter	\$223.25
M.0280.48.00	48" Diameter	\$223.25
M.0280.54.00	54" Diameter	\$356.25
M.0280.60.00	60" Diameter	\$433.75
<b>SQUARE TABLE TOP</b>		
M.0291.24.00	24" Diameter	\$80.75
M.0291.30.00	30" Diameter	\$88.75
M.0291.36.00	36" Diameter	\$129.25
M.0291.42.00	42" Diameter	\$223.25
M.0291.48.00	48" Diameter	\$223.25
M.0291.54.00	54" Diameter	\$356.25
M.0291.60.00	60" Diameter	\$433.75

\* NOTE: MINIMUM ORDER QUANTITY - 5 WORK SURFACE TOPS, ADDITIONAL FEES APPLIED IF LESS THAN 5 ORDERED  
 \* FOR HIGH PRESSURE TOP + TRIM COLOR CHOICES, PLEASE VIEW REFERENCE PAGE 82

# ADDITIONAL WORK SURFACES

ADDITIONAL WORK SURFACE SHAPES AVAILABLE IN HIGH PRESSURE OR MELAMINE UPON REQUEST

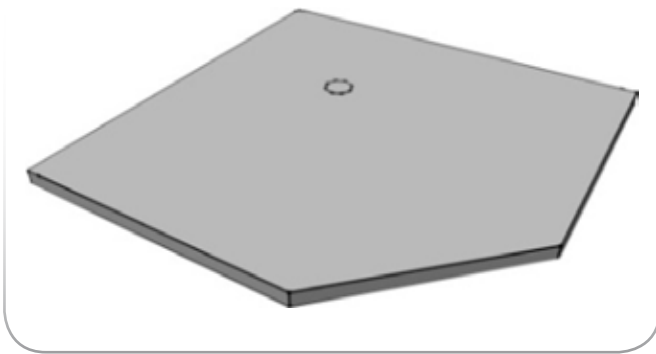

Corner

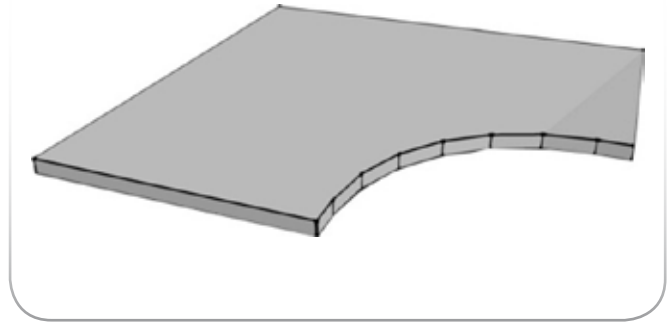

Curve Corner

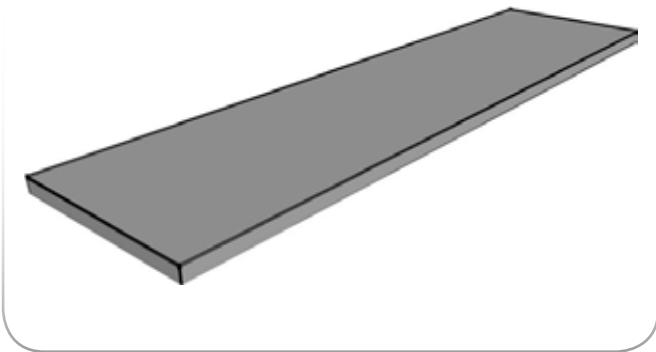

Counter Cap

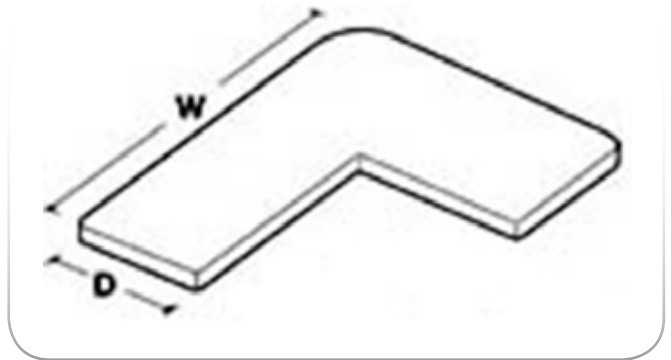

Counter Cap Corner

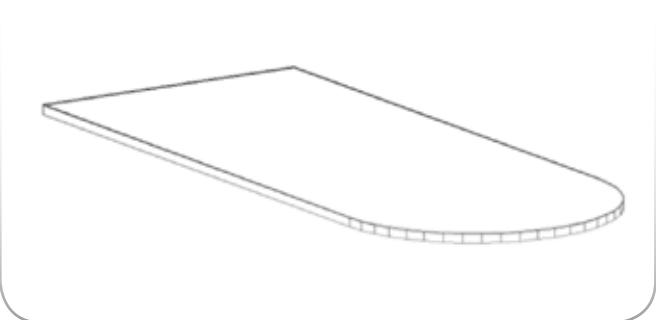

Peninsula

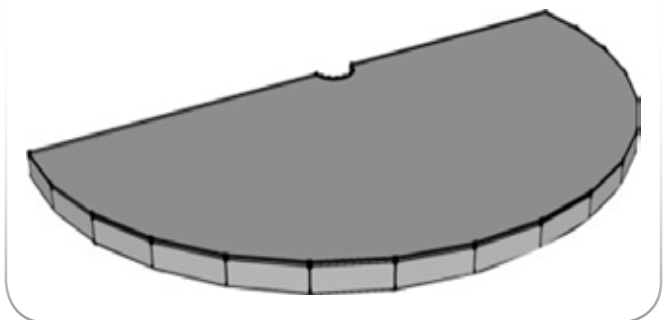

Half Round

\* NOTE: MINIMUM ORDER QUANTITY - 5 WORK SURFACE TOPS, ADDITIONAL FEES APPLIED IF LESS THAN 5 ORDERED  
\* FOR HIGH PRESSURE TOP + TRIM COLOR CHOICES, PLEASE VIEW REFERENCE PAGE 82

# STEELCASE + HAWORTH PARTS



# STEELCASE + HAWORTH PARTS

## STEELCASE HARDWARE



### AVENIR CONNECTOR KIT

SKU	S.0004.01.BK
Price	\$3.50



### ST 9000 4" PANEL GLIDE

SKU	S.0011.01.BK
Price	\$1.75



### ST 9000 TACK BOARD CLIP

SKU	S.0030.03.UP
Price	\$13.00 / pair



### ST 9000 END PANEL WIRE COVER

SKU	Hole	Price
S.0036.01.UP	N	\$8.00
S.0036.02.UP	Y	\$7.00



### ST 9000 CORNER BRACKET

SKU	S.0010.01.BK
Price	\$5.00 / pair



### ST 9000 ADAPTER BRACKET

SKU	S.0007.01.BK
Price	\$3.00



### ST 9000 MURPHY BRACKET

SKU	S.0009.01.BK
Price	\$8.50



### ST 9000 STABILIZER BRACKET

SKU	S.0012.01.BK
Price	\$8.00

## HAWORTH HARDWARE



### TACK BOARD MOUNTING CLIP

SKU	H.0081.01.UP
Price	\$7.00 / pair



### COUNTER CAP SUPPORT BRACKET

SKU	H.0082.01.UP
Price	\$7.00 / pair



### PANEL MOUNTED SUPPORT BRACKET

SKU	H.0083.01.UP
Price	\$3.50



### WORK SURFACE GANGING BRACKET

SKU	H.0067.01.BK
Price	\$3.00

# REFERENCES



\* NOTE: DUE TO VARIATIONS IN MONITOR DISPLAY AND PRINT SETTINGS, THE FOLLOWING COLOR CHARTS SHOULD BE USED FOR GENERAL GUIDANCE AND NOT AS A TRUE REPRESENTATION OF THE APPEARANCE OF FINISHED PRODUCTS. ACTUAL METAL CHIPS ARE AVAILABLE UPON REQUEST FOR TABLE LEGS + STORAGE COLORS.

# TABLE LEG SAMPLE COLOR CHART



HM BLACK UMBER (BU)



HM MEDIUM TONE (MT)



HM INNERTONE (HT)



HM INNERTONE LIGHT (HF)

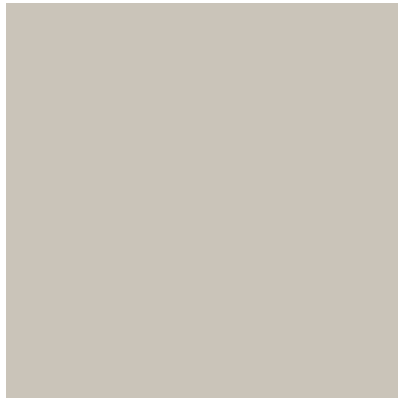

HM LIGHT GREY (LG)



HM LIGHT TONE (LT)



PLATINUM (PL)

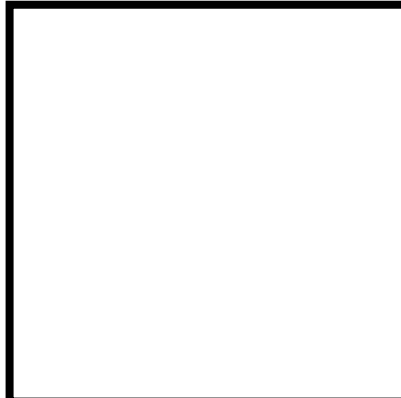

SKY WHITE (SW)



ADDITIONAL  
COLORS  
AVAILABLE  
UPON  
REQUEST

\* PAINTED LEGS WILL REQUIRE A MINIMUM OF 8 TO BE ORDERED - 2 WEEK LEAD TIME  
\* IF LESS THAN 8 ORDERED, A \$60 UPCHARGE WILL BE ADDED TO YOUR ORDER

# STORAGE SAMPLE COLOR CHART

## INDUSTRY STANDARD COLORS



**HM Black Umber**  
BU



**HM Dark Tone**  
DT



**HM Innertone**  
HT



**HM Innertone LT**  
HF



**HM Just Tan**  
JT

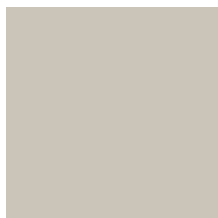

**HM Light Grey**  
HL



**HM Light Tone**  
LT



**HM Medium Tone**  
MT



**HM Soft White**  
LU



**HW Beige**  
BE

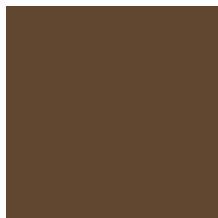

**HW Browntone**  
BT

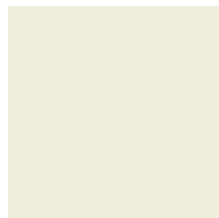

**HW Chalk**  
CK



**HW Charcoal**  
CH



**HW Clay**  
CL



**HW Graphite**  
GP

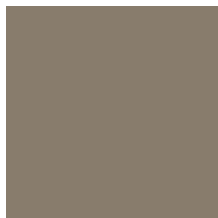

**HW Greystone**  
GT

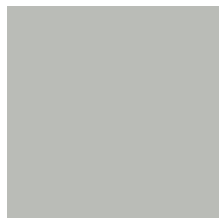

**HW Platinum**  
HP

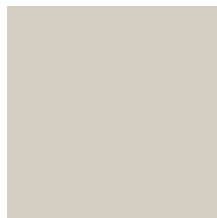

**HW Putty**  
PY



**HW Sand**  
SD

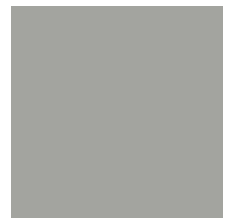

**HW Smoke**  
SM



**HW Stone**  
ST



**HW Tan**  
TA



**KN Folkstone Grey**  
FG



**KN Lakeshore Grey**  
LG



**KN Medium Grey**  
MG

# STORAGE SAMPLE COLOR CHART



**KN MG Textured**  
MX



**KN Sandstone**  
SS

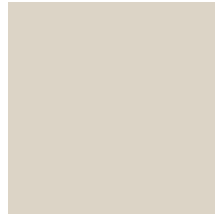

**KN Soft Grey**  
SG



**SC Black**  
BK



**SC Black Textured**  
BX



**SC Fieldstone Textured**  
FS



**SC Grey Value 1**  
GV



**SC Platinum  
(Metallic)**  
PM



**SC Smoke**  
SK



**SC Tan Value 1**  
TV

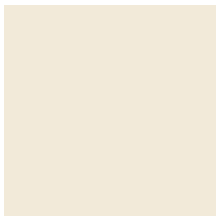

**SC Warm White**  
WW

**HM = HERMAN MILLER    HW = HAWORTH    KN = KNOLL    SC = STEELCASE**

## EXCLUSIVE COLORS

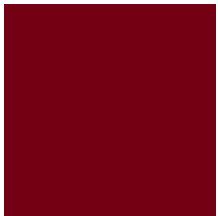

**Burgundy**  
BY



**Green**  
GR



**Sea Blue**  
SB



**Light Blue**  
LB



**Deep Blue**  
DB

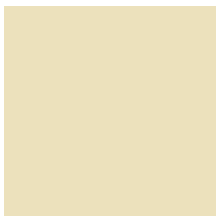

**Light Almond**  
LA



**Ivory**  
IV



**Beige**  
BG



**Dark Taupe**  
TD



**Matte Grey**  
MA

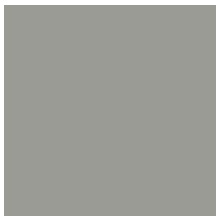

**Platinum**  
PL

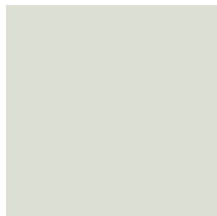

**Off White**  
OW

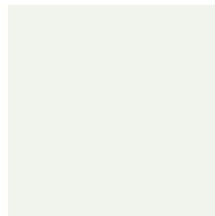

**Appliance White**  
AW



**Pac Black**  
PB

# CUSHIONED TOP PEDESTAL FABRICS

## NEW HEMPSTEAD COLLECTION



**Raspberry**  
NH388



**Fire**  
NH406



**Red Red Wine**  
NH389



**Brick**  
NH434



**Emberglow**  
NH416



**Canary**  
NH427



**Lake**  
NH423

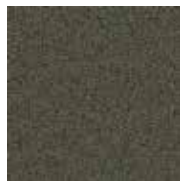

**Zen**  
NH425

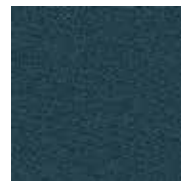

**Azure**  
NH359



**Steel**  
NH366



**Navy**  
NH369



**Galaxy**  
NH509



**Aubergine**  
NH419



**Napa**  
NH422

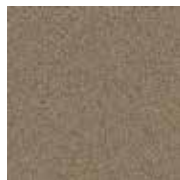

**Jodhpurs**  
NH420



**Cocoa**  
NH424



**Nickel**  
NH361



**Grey**  
NH395



**Black**  
NH333

## BRYANT PARK COLLECTION



**Raspberry**  
6557



**Medoc**  
6552



**Burgundy**  
6550



**Marigold**  
6551



**Curry**  
6556



**Crocodile**  
6561



**Hemlock**  
6559

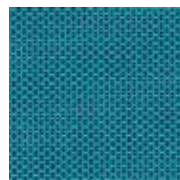

**Nile**  
6553



**Dusk**  
6554



**Saxon Blue**  
6558

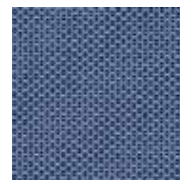

**Night Shadow**  
6563

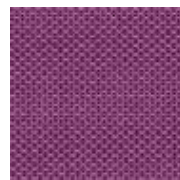

**Violet**  
6562

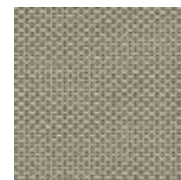

**Pumice**  
6555



**Chocolate**  
6564

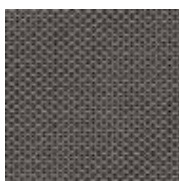

**Gunmetal**  
6560

# STORAGE DRAWER PULLS

Made in the USA from high quality, solid metal. Other styles available upon request.

PLEASE NOTE:

- Recessed Pulls are **only** available on pedestal and lateral drawers. **Not** available on storage cabinet or wardrobe doors.
- Droop Pull is painted to match drawer front
- Long Rod Pull is an additional \$5.00 upcharge per drawer and is only available on lateral files



FULL PULL (S)



RECESSED PULL (M)



LOOP PULL (A)



TWIST PULL (T)



ECLIPSE PULL (E)



DROOP PULL (D)



BAR PULL (B)



SHORT ROD PULL (O)



LONG ROD PULL (L)

# STEELCASE CHAIR FABRIC CHART



**Magenta**  
2692



**Geranium**  
2084



**Poppy**  
2091



**Red Delicious**  
2014



**Pumpkin**  
2021



**Amber**  
2020



**Sunshine**  
2082



**Vanilla**  
2130



**Straw**  
2034



**Goldenrod**  
2090

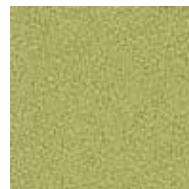

**Green Olive**  
2048

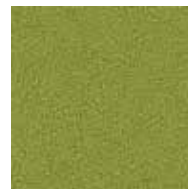

**Green Apple**  
2087

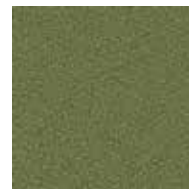

**Willow**  
2028



**Pine Needle**  
2022



**Eucalyptus**  
2047



**Sea**  
2077



**Quarry Blue**  
2026



**Waterfall**  
2691



**Lapis**  
2094



**Thistle**  
2085



**Cobalt**  
2045



**Deep Water**  
2051



**Midnight**  
2025



**Henna**  
2052

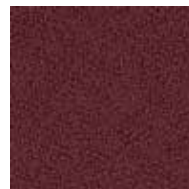

**Mulberry**  
2044



**Aubergine**  
2036

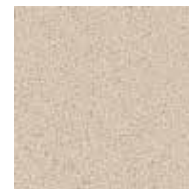

**Birch**  
2129

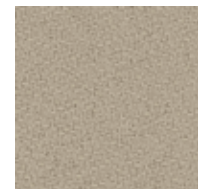

**Angora**  
2035



**Cumin**  
2050



**Goose**  
2049



**Coffee Bean**  
2083



**Slate**  
2017



**Asteroid**  
2053



**Wolf**  
2027



**Fossil**  
2093



**Graphite**  
2079

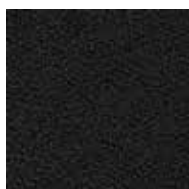

**Onyx**  
2016

# MELAMINE COLOR CHOICES

## MELAMINE WORK SURFACE TOP COLOR CHOICES



MAPLE 304



CHERRY 303



WHITE SAND 301



GREY SAND 302

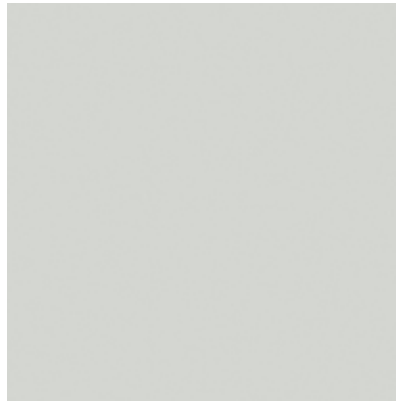

GREY 305

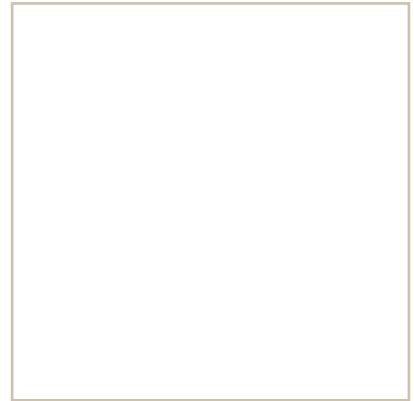

CLASSIC WHITE 306

## MELAMINE WORK SURFACE 3MM TRIM COLOR CHOICES



HM BLACK UMBER (BU)

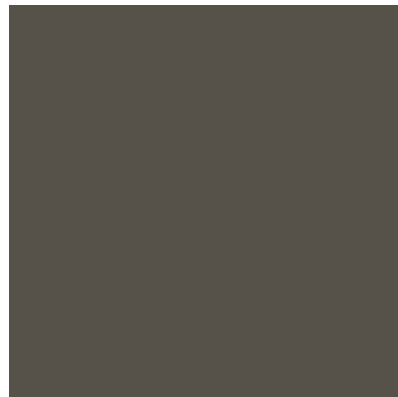











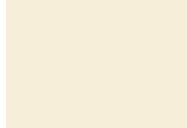

HM MEDIUM TONE (MT)



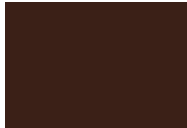
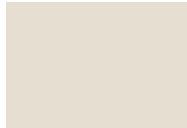



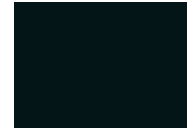







# HIGH PRESSURE COLOR CHOICES

## HIGH PRESSURE WORK SURFACE TOP COLOR CHOICES

### SOLID COLORS

						
<b>Cafe Creme</b> D456	<b>Sand</b> D331	<b>Natural Almond</b> D30	<b>Light Beige</b> 1531	<b>Beige</b> 1530	<b>Khaki Brown</b> D50	<b>Pepperdust</b> D327
						
<b>Shadow</b> D96	<b>Coffee Bean</b> D495	<b>Grey</b> 1500	<b>Dove Grey</b> D92	<b>Platinum</b> D315	<b>North Sea</b> D90	<b>Black</b> 1595

### WOOD GRAINS

						
<b>Harvest Maple</b> 7953	<b>Castle Oak</b> 7928	<b>Beigewood</b> 7850	<b>Fusion Maple*</b> 7909	<b>Wild Cherry*</b> 7054	<b>Tuscan Walnut</b> 7921	<b>Huntington Maple</b> 7929
						
<b>Solar Oak</b> 7816	<b>Bannister Oak</b> 7806	<b>Manitoba Maple</b> 7911	<b>Neowalnut</b> 7991	<b>Lowell Ash</b> 7994	<b>Boardwalk Oak</b> 7983	<b>Florence Walnut</b> 7993

### ABSTRACT PATTERNS

						
<b>Natural Nebula</b> 4633	<b>Cloud Nebula</b> 4630	<b>Grey Nebula</b> 4622	<b>White Nebula</b> 4621	<b>Graphite Nebula</b> 4623	<b>Desert Zephyr</b> 4841	<b>Spiced Zephyr</b> 4859
						
<b>Loden Zephyr</b> 4844	<b>Canyon Zephyr</b> 4842	<b>Misted Zephyr</b> 4843	<b>Twilight Zephyr</b> 4845	<b>Shadow Zephyr</b> 4857	<b>Cloud Zephyr</b> 4856	<b>Morro Zephyr</b> 4846
						
<b>Ginseng Tea</b> 4909	<b>Western Bronze</b> 4873	<b>Western Storm</b> 4872	<b>Western Suede</b> 4871	<b>Western White</b> 4869	<b>Carbon Mesh</b> 4880	<b>Silicon EV</b> 4811

# HIGH PRESSURE COLOR CHOICES

## ABSTRACT PATTERNS CONTINUED



**Carbon EV**  
4820



**Tungsten EV**  
4814



**Nickel EV**  
4813



**Titanium EV**  
4810



**Beige Pampas**  
4170



**Grey Pampas**  
4168



**Pampas**  
4166



**Organic Cotton**  
4945



**Natural Cotton**  
4946



**Raw Cotton**  
4947



**Evening Tigris**  
4674



**Green Tigris**  
4667



**Natural Tigris**  
4669



**White Tigris**  
4783

## HIGH PRESSURE WORK SURFACE 3MM TRIM COLOR CHOICES

### HERMAN MILLER COLORS



**Black Umber**  
BU



**Dark Tone**  
DT



**Innertone**  
HT



**Innertone Light**  
HF



**Light Grey**  
LG



**Medium Tone**  
MT



**Light Tone**  
LT

### WOOD GRAINS



**Fusion Maple**  
7909



**Wild Cherry**  
7054

ADDITIONAL COLORS FOR HIGH PRESSURE WORK SURFACE TOP AND TRIM AVAILABLE UPON REQUEST

## HOW CAN I ORDER PARTS FROM UNISOURCE?

Unisource products can be purchased on our website, via email, or through one of our sales representatives.

## WHEN WILL MY ORDER SHIP?

Acknowledgements will be emailed and include a ship date. Unisource's goal will always be to try to ship on the specified date. Orders placed with products in stock will generally ship in 1-2 business days. However, orders including custom paint or work surfaces will ship in about 2 weeks. Please see page 86 to view approximate transit time from our location. Unisource will not be liable for any shipping charges or damages due to late shipment.

## WHAT IS THE DIFFERENCE BETWEEN HERMAN MILLER AO1 AND AO2 SYSTEMS?

There are not many differences between AO1 and AO2 systems. However, the biggest difference is that AO2 contains a 5" raceway base while AO1 does not.

## WHAT IS THE DIFFERENCE BETWEEN ACTUAL AND NOMINAL MEASUREMENTS?

Actual measurements are the actual size of the part. The nominal measurements are the size of the panel or work surface that the part will be attaching to.

Example: The actual measurement of the 24" C-Leg with Glides is 22". However, the nominal measurement is 24". This means that the 22" C-Leg will fit a work surface that measures at least 24" deep.

## I'M UNSURE WHAT PRODUCT IT IS I'M LOOKING FOR, HOW WOULD I FIND OUT?

If you're unsure what product it is you're looking for, please do not hesitate to call customer service at [1-800-598-7278](tel:1-800-598-7278). Our office furniture experts will gladly help you find the exact part you need. If you have a picture, please email it to us at [cs@unisourceparts.com](mailto:cs@unisourceparts.com). This will help us discover exactly what it is you need.

## I LIVE LOCALLY, CAN I PICK UP MY ORDER?

If you live around the Grand Rapids area, you may pick up your order. Please notify us if you will be picking up. The acknowledgement emailed to you will contain the date your order will be ready to pick up. We ask that you come on the specified date to ensure your order is ready.

# HOW TO ORDER ONLINE

## SEARCH AND ORDER THE PARTS YOU NEED

- 1. Find Products** - Use our "Shop By Departments" fly out menu to find the products you're looking for based on category
- 2. View Details** - Click on the product to view easy-to-read details and options
- 3. Add to Cart** - Enter the quantity desired
- 4. Proceed to Checkout** - Enter billing/shipping address along with payment information
- 5. Place Order** - Once order has been submitted and payment is confirmed, you will receive an acknowledgement including estimated ship date and product details. Please Note: Shipping charges will be added to your order before it ships.

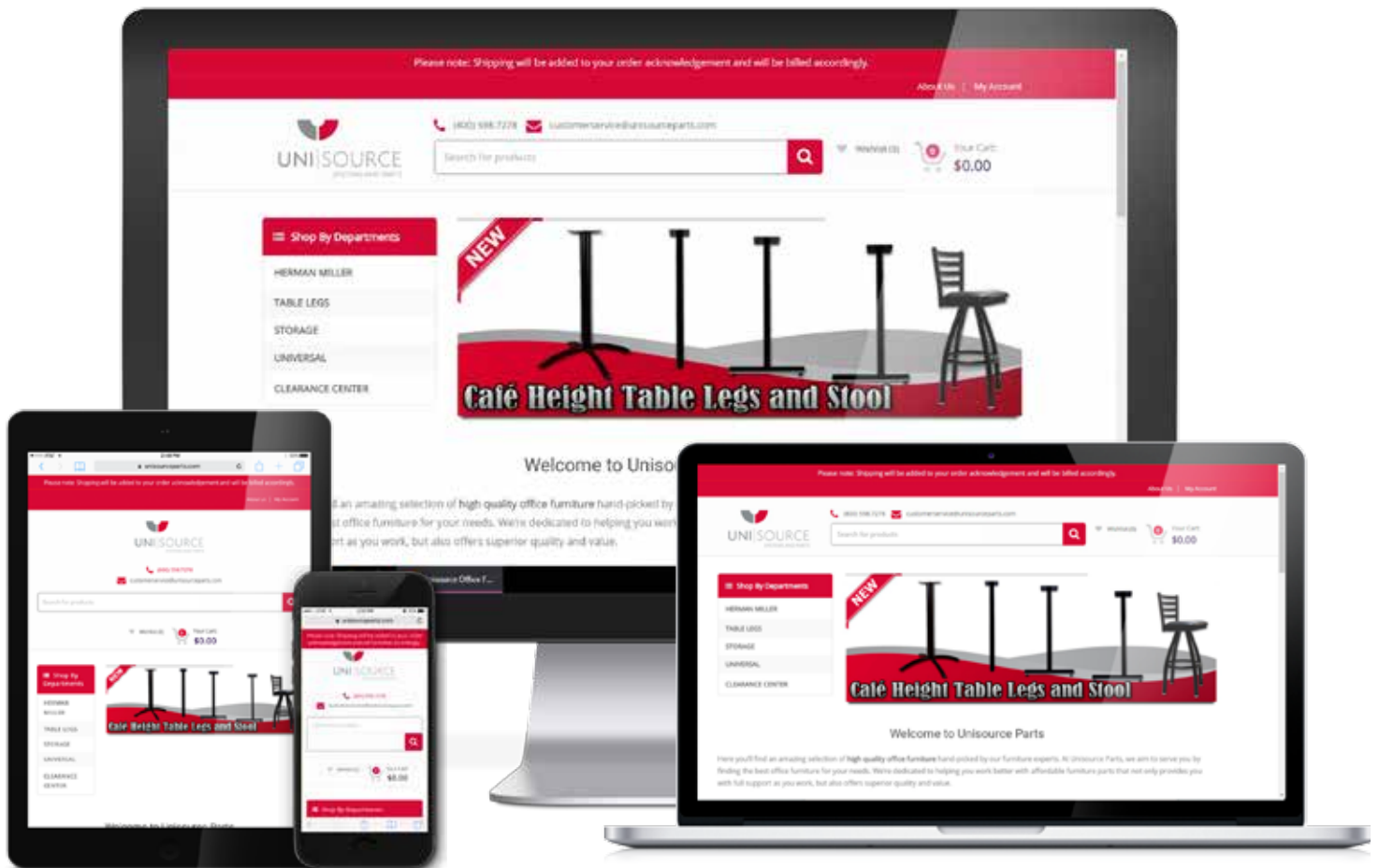

unisourceparts.com

# SHIPPING

## TRANSIT TIMES FROM WALKER, MICHIGAN

**PLEASE NOTE:**

This map is only an estimate. Actual shipping times may vary based on seasons, weather, costs of business, or any other unforeseen circumstance.

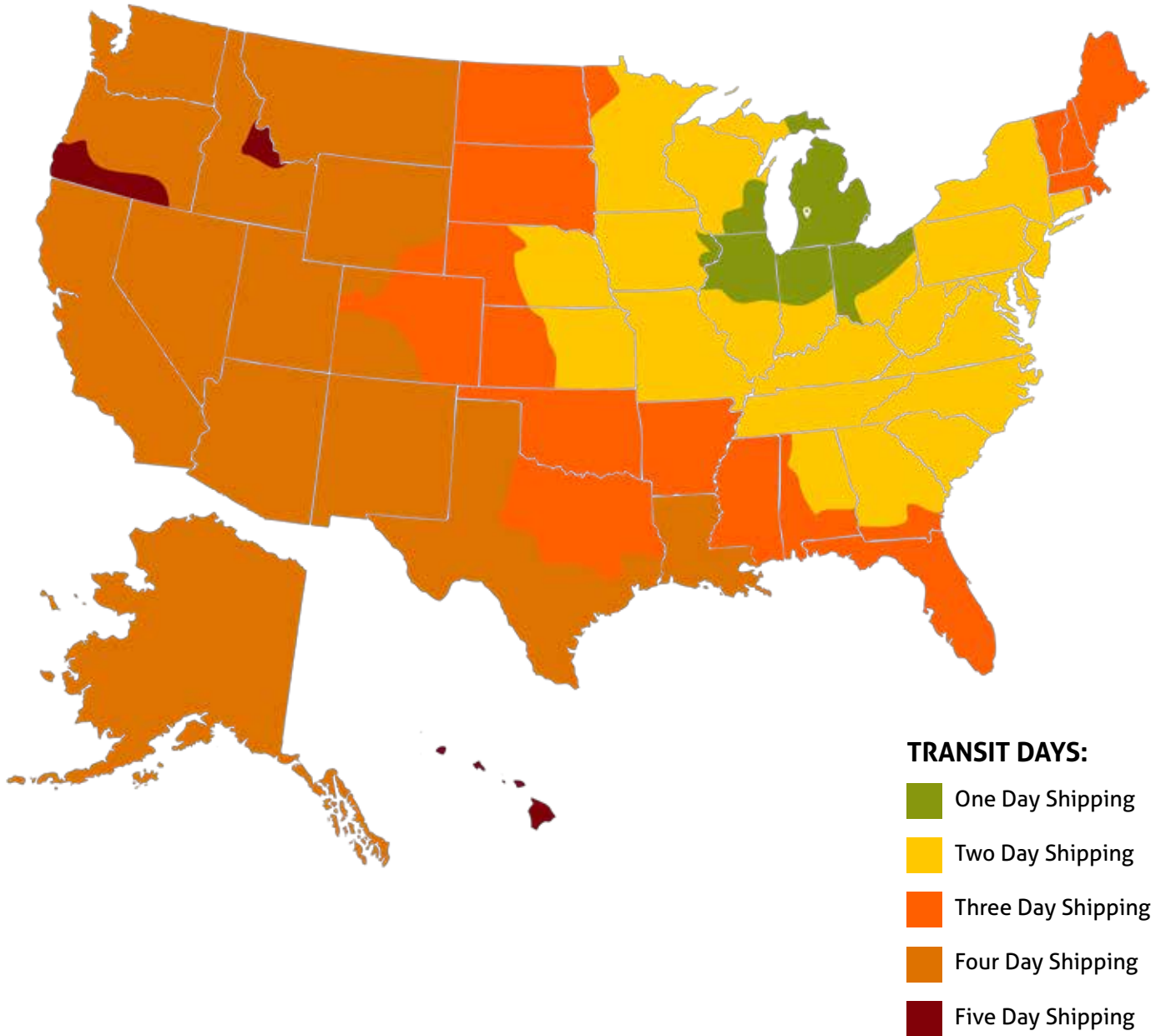

# TERMS & CONDITIONS OF SALE

## TERMS

Terms are Net 30 days or as offered, with approved credit. Prior to approved credit, payment must be received to ship.

Remit payments to: Unisource Office Furniture Parts, Inc.  
2882 Northridge Dr NW  
Walker, MI 49544

Credit cards are accepted with approval (VISA, MasterCard, and AMEX).

## CREDIT

All new customers will be requested to fill out a Unisource credit application form. Note, if your account goes beyond allowed terms, no merchandise will be shipped until past due amounts are paid.

## DEDUCTIONS

No deductions will be allowed from invoices without authorization.

## PARTIAL SHIPMENTS

Partial shipments will be made on customer request or back order occurrences only. Products shipped will be invoiced and payable in accordance with Unisource Parts terms. The balance of the order will be shipped when it becomes available. Customers will be responsible for freight and handling charges.

## ORDER CHANGES / CANCELLATIONS

Any changes to orders must be submitted in writing to Unisource Parts for pre-approval. The standard restocking fee is 25% upon inspection and repackaging. However all non-stock items, including specialty items, cannot be cancelled or returned.

## RETURNS / CREDITS

No merchandise will be accepted for exchange or credit without expressed authorization prior to the return of goods. Unisource Parts must be notified of returns, quality problems or shortages within 10 days of receipt of goods. All freight charges on returned merchandise must be prepaid. Unisource Parts will not accept freight collect shipments.

## TRANSIT DAMAGE

All merchandise is packed in an approved manner. Please inspect all merchandise immediately upon receipt. If merchandise is or appears to be damaged do not unpack, contact carrier for inspection. Notification of concealed damage must be made to the freight company delivering the goods. Title to the goods and risk pass along to the buyer once Unisource Parts or its vendor delivers its goods to the carrier. It is recommended that you notify the freight company in writing during delivery and follow up with a phone call to file freight claim.

## REDELIVERY OF FREIGHT

When redelivery of merchandise is required because the customer is unable to accept the merchandise and no notification of this fact was given to Unisource Parts, the actual cost of freight, rehandling and warehousing, plus a 10% surcharge, will be billed to the customer.

## PRODUCT DESIGN

Unisource Parts reserves the right to make changes to design and construction and discontinue products without prior notice. All dimensions shown are considered to be approximate.

## PRICES

All prices are quoted in US dollars and are subject to change without notice.

## WARRANTIES

Unisource Parts warrants its products to be free from defects in material and workmanship for a period of one (1) year from the date of initial delivery. This warranty is made by Unisource Parts only to purchasers acquiring the product from Unisource Parts or its authorized dealers. Unisource Parts' obligation and the purchasers remedy pursuant to this warranty are limited to repair or replacement, at Unisource Parts' discretion, of parts of which prove, under normal use, to be defective within the period stated. This remedy is expressly agreed to be exclusive as a condition of replacement. No person, firm or corporation is authorized to assume for Unisource Parts any other liability in connection with Unisource Parts products.

THERE ARE NO OTHER WARRANTIES EXCEPT AS EXPRESSLY SET FORTH ABOVE, EITHER EXPRESSED OR IMPLIED, INCLUDING ANY WARRANTY OF MERCHANTABILITY OF FITNESS FOR ANY PARTICULAR PURPOSE. UNISOURCE PARTS' LIABILITY WITH RESPECT TO ITS PRODUCTS SHALL NOT EXCEED THAT EXPRESSLY SET FORTH ABOVE IRRESPECTIVE OF THE THEORY UPON WHICH ANY CLAIM MIGHT BE BASED INCLUDING BREACH OF CONTRACT, WARRANTY, NEGLIGENCE, OR STRICT LIABILITY ON TORT, UNDER NO CIRCUMSTANCES SHALL Unisource Parts BE LIABLE FOR SPECIAL, INCIDENTAL, OR CONSEQUENTIAL DAMAGES.

This warranty does not apply to damages resulting from shipment, storage, accident, alteration, misuse, assembly or installation. All claims under this warranty must be made in writing prior to the repair or replacement of the product.



**UNISOURCE OFFICE FURNITURE PARTS, INC.**

2882 Northridge Dr NW, Walker, MI 49544

**Phone:** 1.800.598.7278

**Email:** [cs@unisourceparts.com](mailto:cs@unisourceparts.com)

**Web:** [www.unisourceparts.com](http://www.unisourceparts.com)

**Hours:** 8:30am - 5:00pm EST

 [www.facebook.com/UnisourceParts](http://www.facebook.com/UnisourceParts)

 [@unisourceparts](https://www.instagram.com/unisourceparts)

 [www.twitter.com/UnisourceParts](http://www.twitter.com/UnisourceParts)